

Draft Instructions

Please follow the following steps in order to get the correct draft

- Download the PDF and Print it out on A4 size Paper.
- Ensure that your Printer is set to General and Page Position is Centered.
- Cut along the outer margins printed on the sheets
- Join the sheets together following the number pattern on them, as shown in the reference image below
- Your Draft is Ready

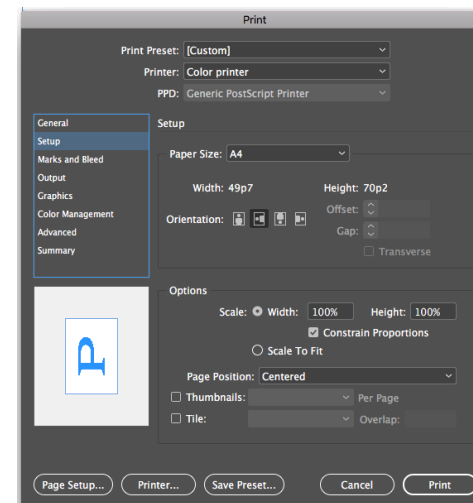
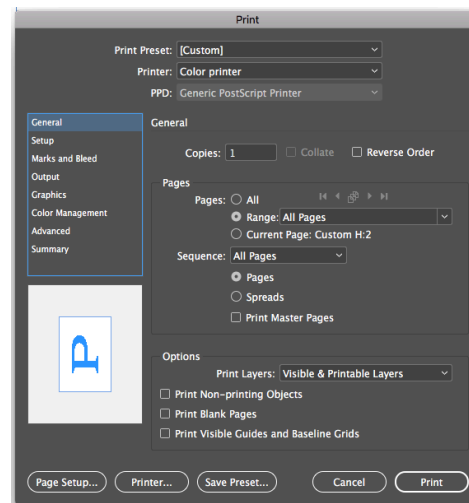

Size Chart

Age Group / Measurements	4 to 5	5 to 6	6 to 7	7 to 8	8 to 9	9 to 10	10 to 11	11 to 12
Dress Length (Inclusive of allowance)	23"	23.5"	24"	25"	26"	27"	28"	29"
Across Chest Level (With Ease)	10.5"	11"	11.5"	11.75"	12"	12.5"	12.75"	13"
Acroos Front(Inclusive of allowance)	7.5"	8"	8.5"	8.75"	9"	9.5"	9.75"	10"
Chest Length	5.5"	6"	6.5"	6.75"	7"	7.5"	7.75"	8"
Side Seam Allowance	1/2"	1/2"	1/2"	1/2"	1/2"	1/2"	1/2"	1/2"
Arm Hold (1st Fold)	1/4"	1/4"	1/4"	1/4"	1/4"	1/4"	1/4"	1/4"
Arm Hold (2nd Fold)	1/4"	1/4"	1/4"	1/4"	1/4"	1/4"	1/4"	1/4"
Casing (1st Fold)	1/2"	1/2"	1/2"	1/2"	1/2"	1/2"	1/2"	1/2"
Casing (2nd Fold)	1.50"	1.50"	1.50"	1.50"	1.50"	1.50"	1.50"	1.50"
Bottom Hem (1st Fold)	1/2"	1/2"	1/2"	1/2"	1/2"	1/2"	1/2"	1/2"
Bottom Hem (2nd Fold)	1.50"	1.50"	1.50"	1.50"	1.50"	1.50"	1.50"	1.50"
Actual ready length = 4.5" ribbon length on one side	23.5"	24"	24.5"	25.5"	26.5"	27.5"	28.5"	29.5"

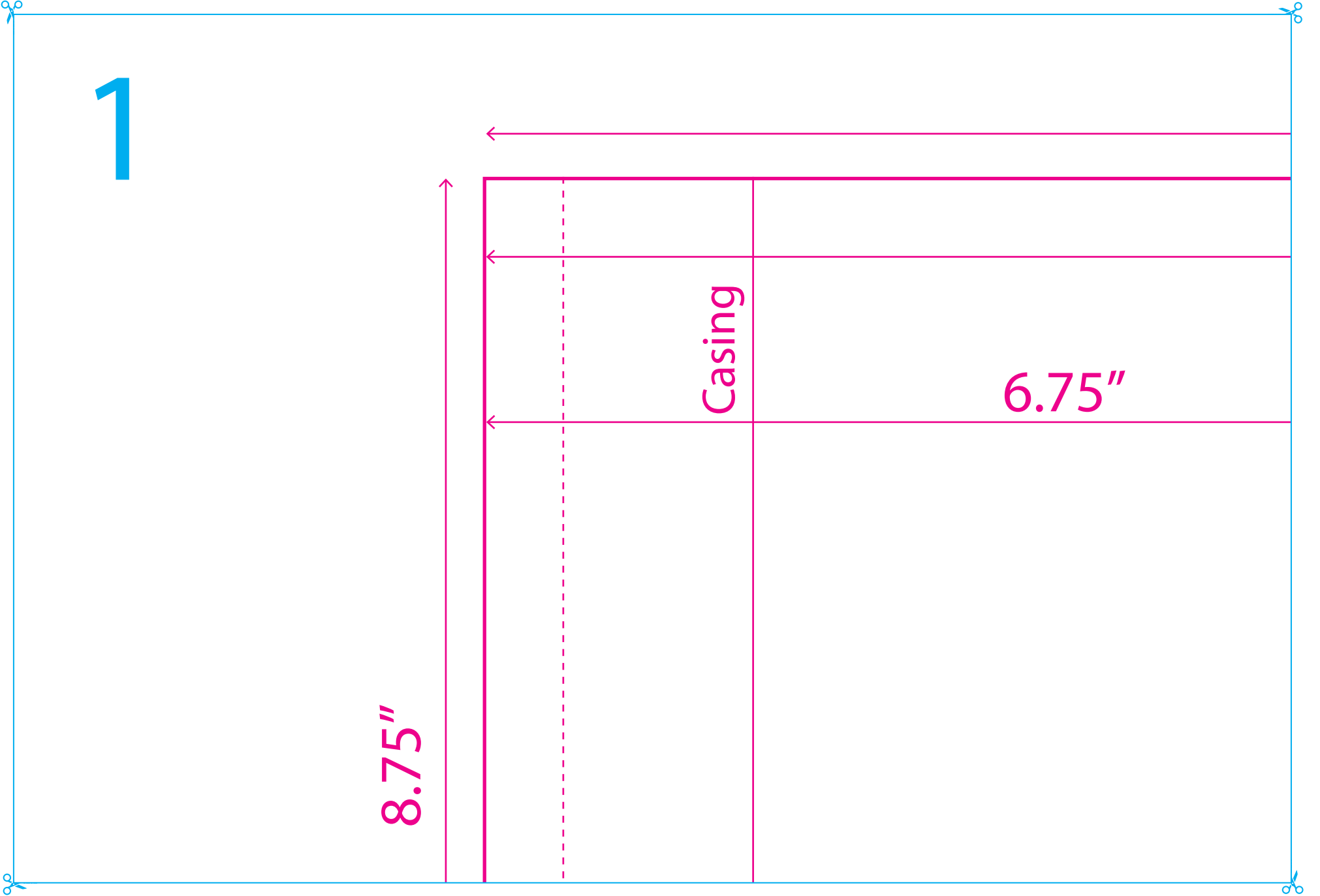

1

8.75"

Casing

6.75"

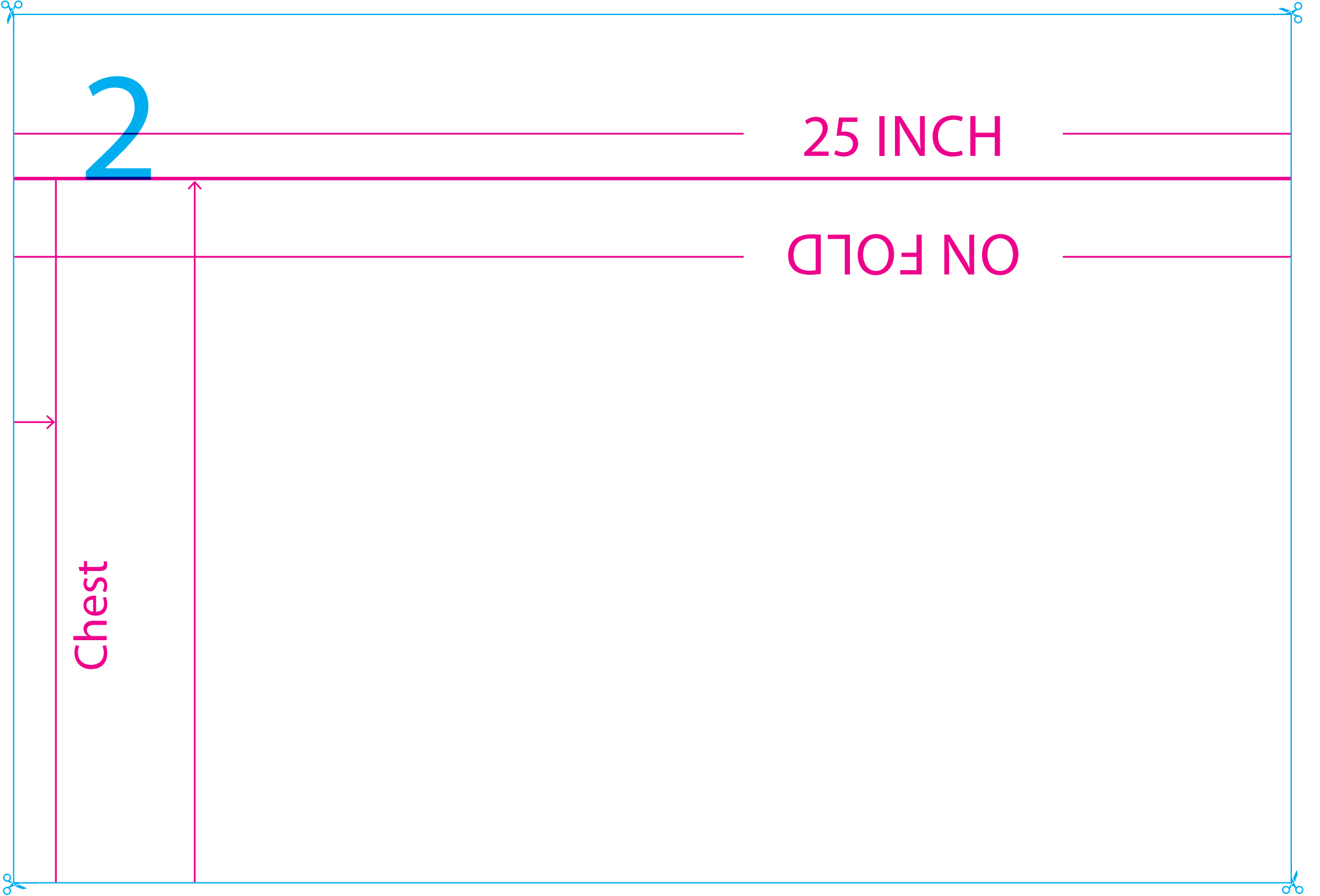

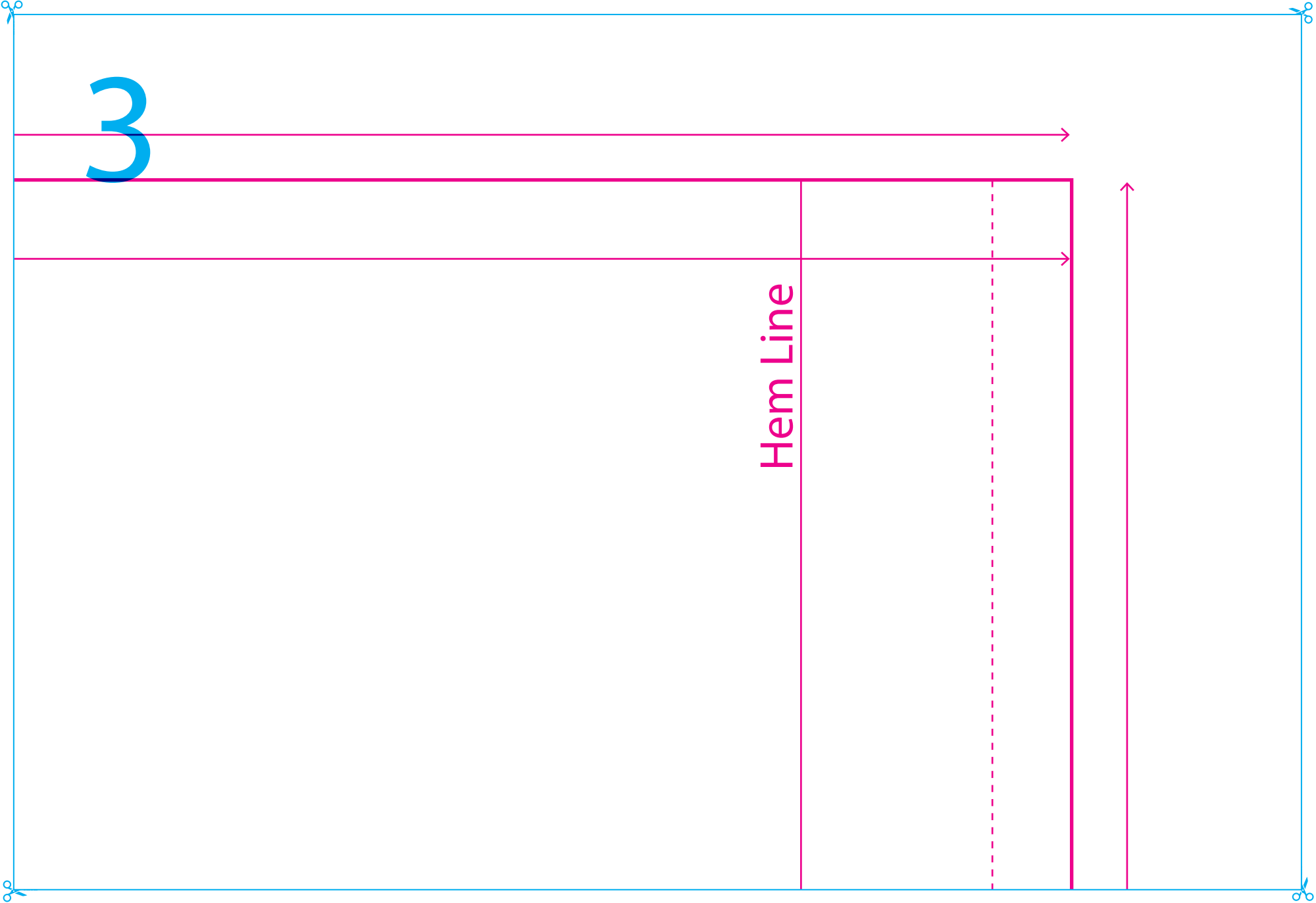

4

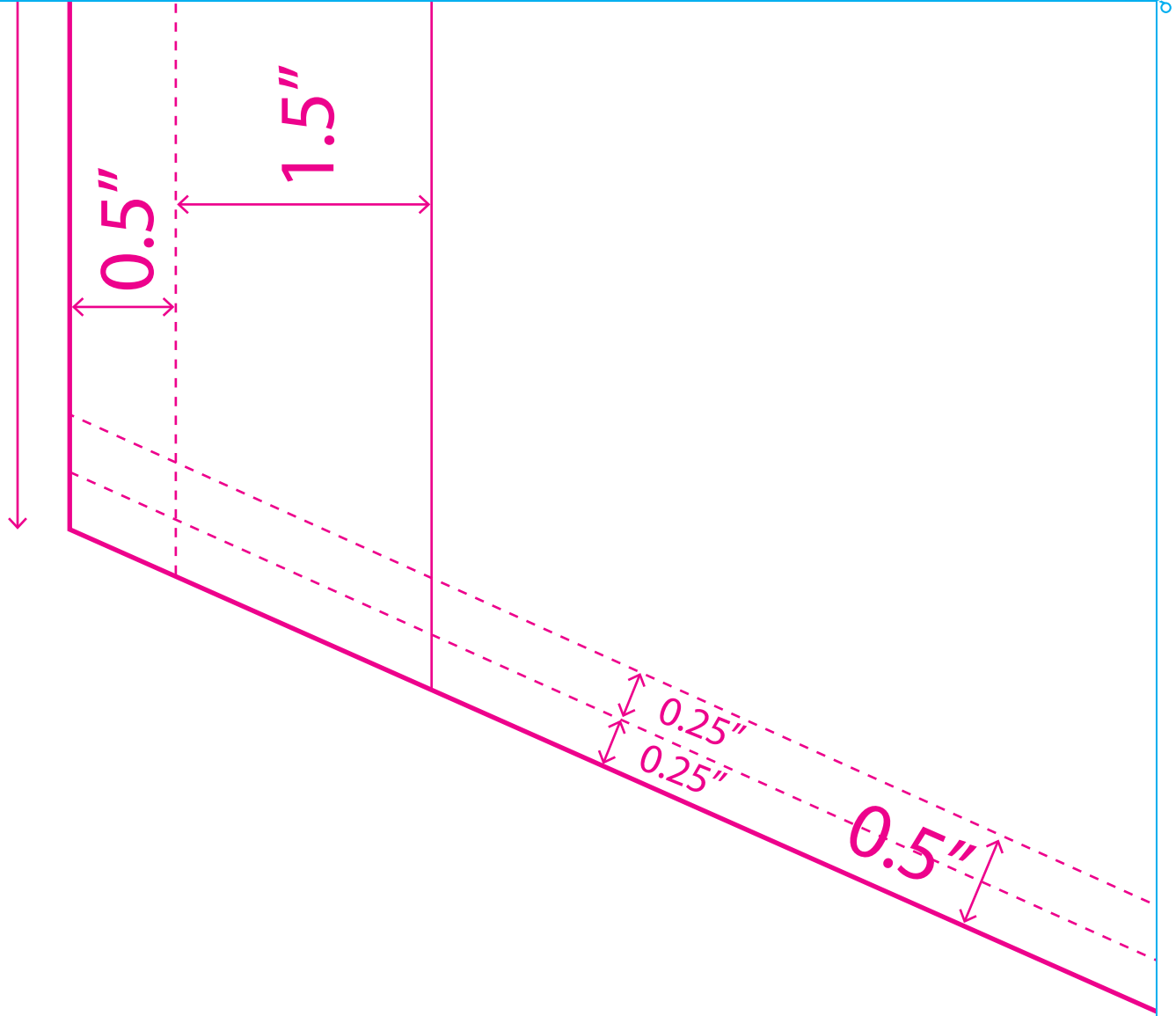

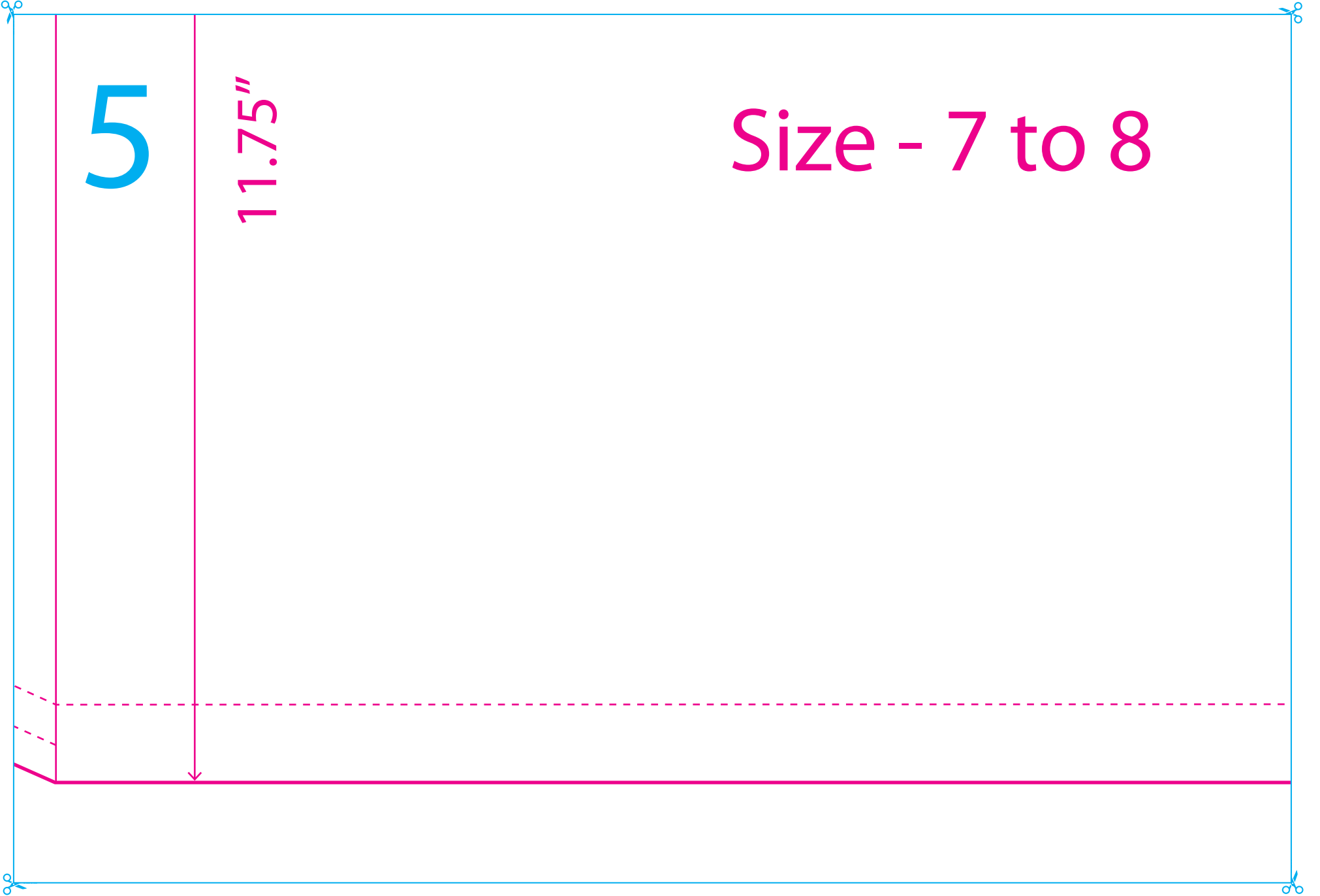

5

11.75"

Size - 7 to 8

