

## Draft Instructions

Please follow the following steps in order to get the correct draft

- Download the PDF and Print it out on A4 size Paper.
- Ensure that your Printer is set to General and Page Position is Centered.
- Cut along the outer margins printed on the sheets
- Join the sheets together following the number pattern on them, as shown in the reference image below
- Your Draft is Ready

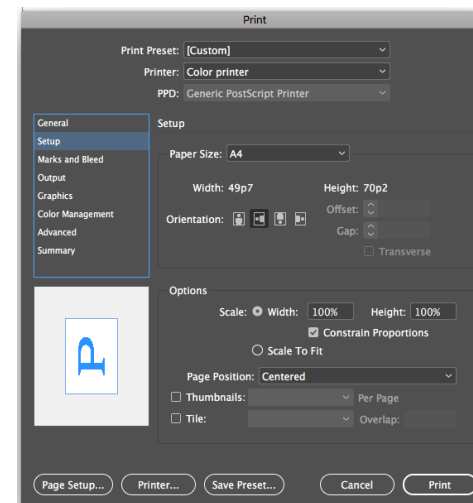
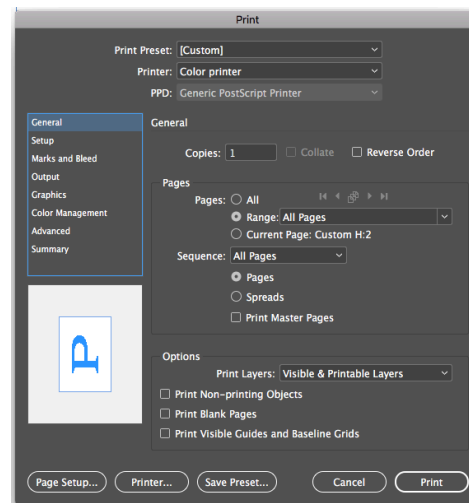

## Size Chart

Age Group / Measurements	4 to 5	5 to 6	6 to 7	7 to 8	8 to 9	9 to 10	10 to 11	11 to 12
Dress Length ( Inclusive of allowance )	23"	23.5"	24"	25"	26"	27"	28"	29"
Across Chest Level ( With Ease )	10.5"	11"	11.5"	11.75"	12"	12.5"	12.75"	13"
Acroos Front( Inclusive of allowance )	7.5"	8"	8.5"	8.75"	9"	9.5"	9.75"	10"
Chest Length	5.5"	6"	6.5"	6.75"	7"	7.5"	7.75"	8"
Side Seam Allowance	1/2"	1/2"	1/2"	1/2"	1/2"	1/2"	1/2"	1/2"
Arm Hold (1st Fold )	1/4"	1/4"	1/4"	1/4"	1/4"	1/4"	1/4"	1/4"
Arm Hold (2nd Fold )	1/4"	1/4"	1/4"	1/4"	1/4"	1/4"	1/4"	1/4"
Casing (1st Fold )	1/2"	1/2"	1/2"	1/2"	1/2"	1/2"	1/2"	1/2"
Casing (2nd Fold )	1.50"	1.50"	1.50"	1.50"	1.50"	1.50"	1.50"	1.50"
Bottom Hem (1st Fold )	1/2"	1/2"	1/2"	1/2"	1/2"	1/2"	1/2"	1/2"
Bottom Hem (2nd Fold )	1.50"	1.50"	1.50"	1.50"	1.50"	1.50"	1.50"	1.50"
Actual ready length = 4.5" ribbon length on one side	23.5"	24"	24.5"	25.5"	26.5"	27.5"	28.5"	29.5"

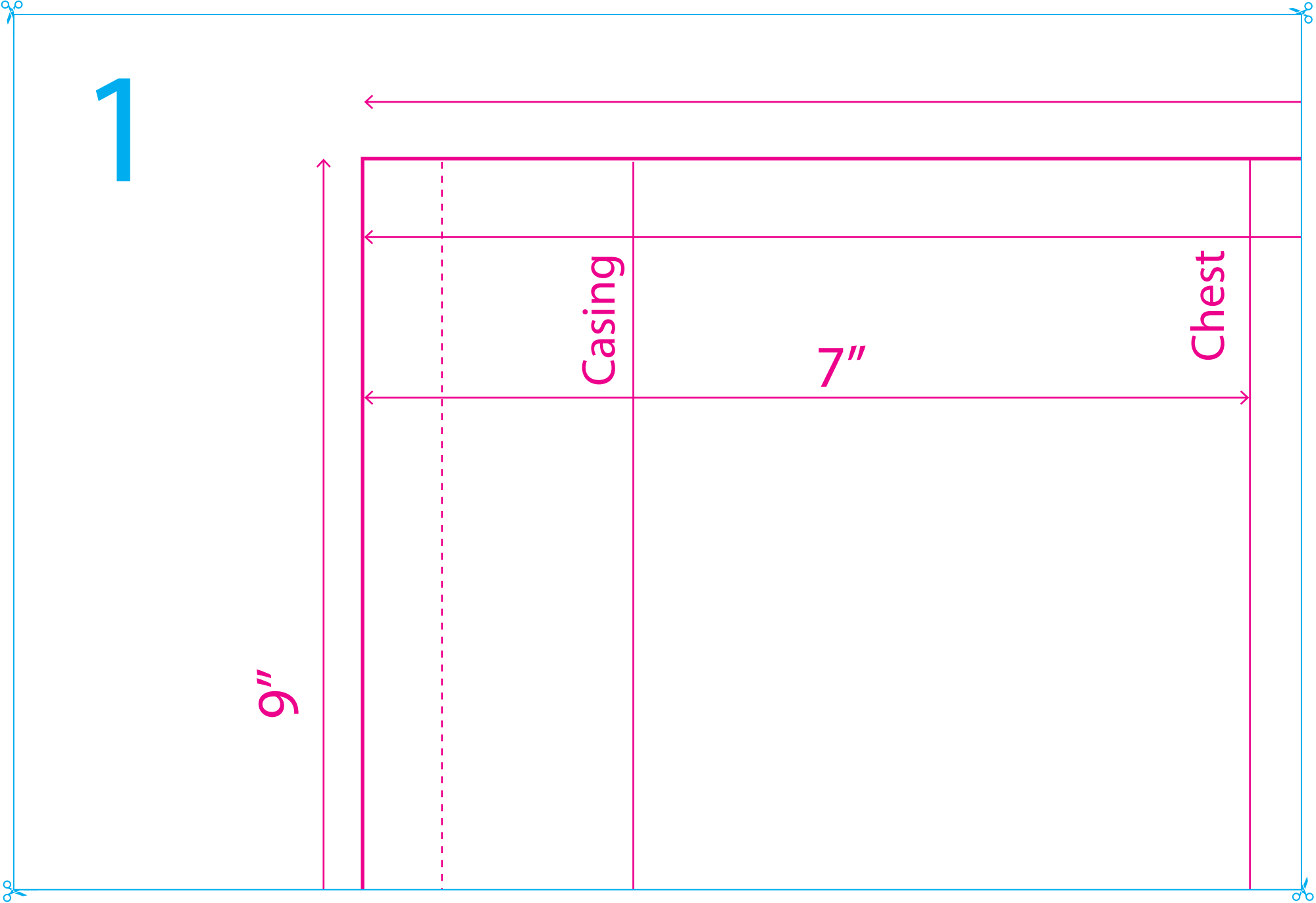

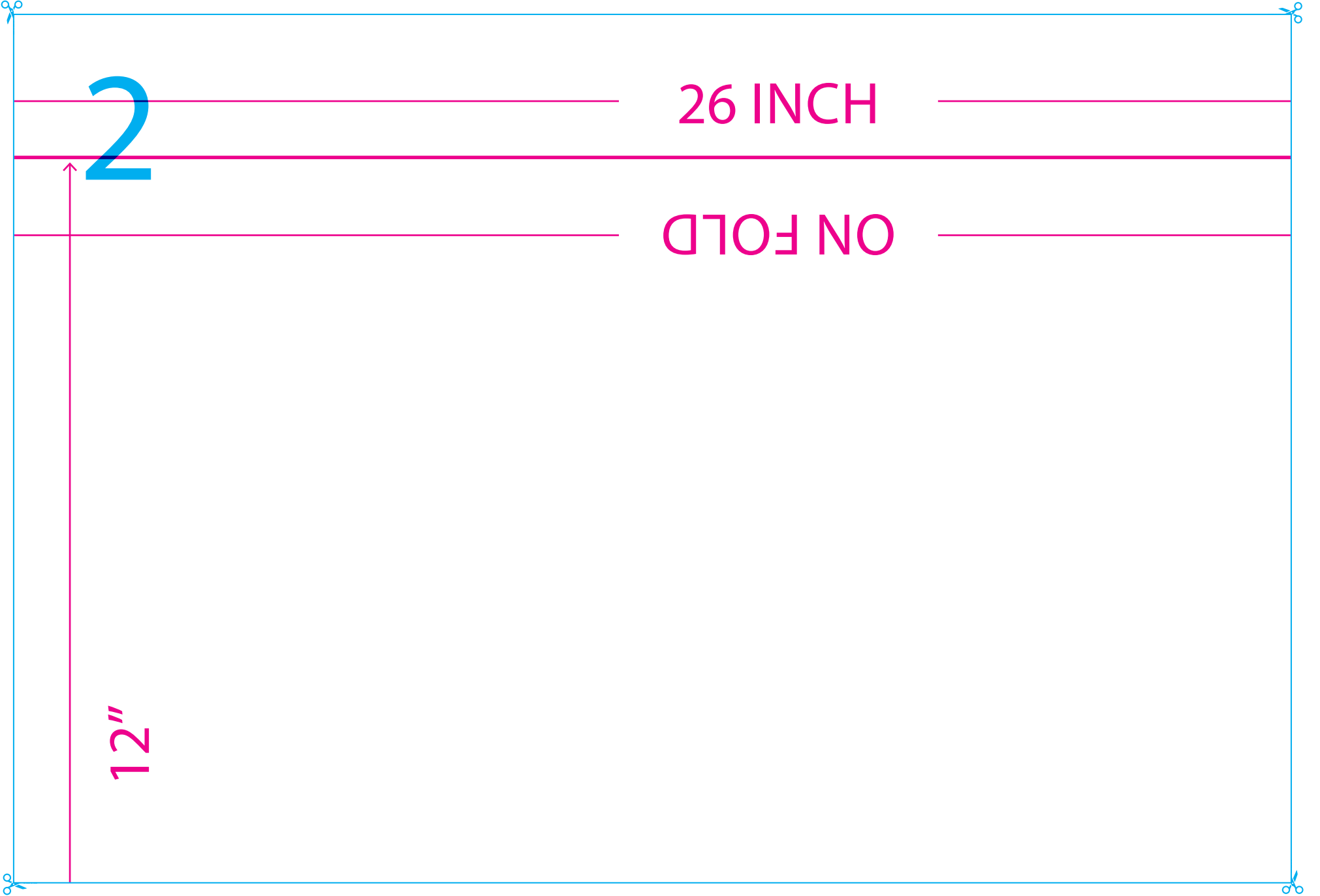

26 INCH

ON FOLD

2

12"

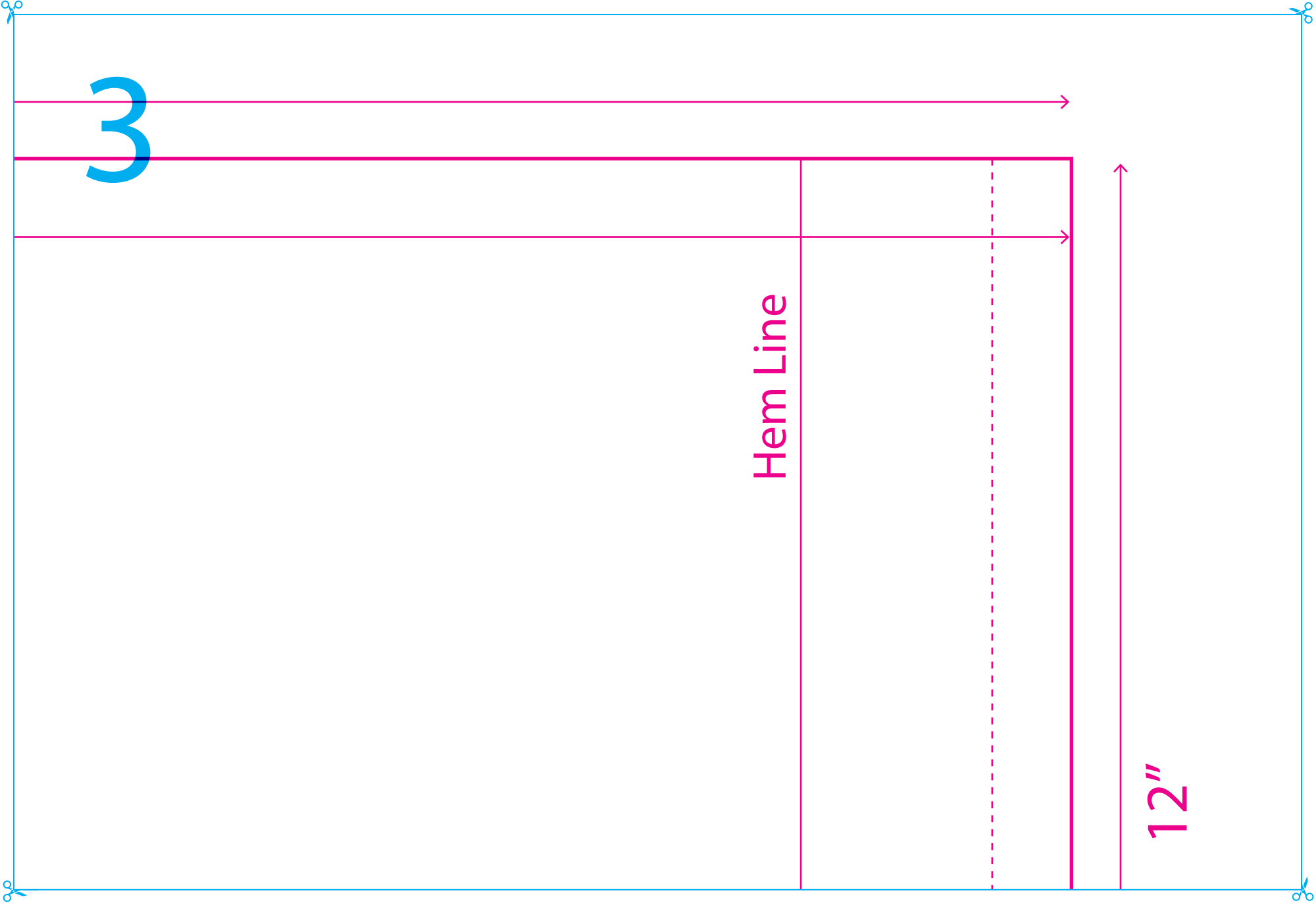

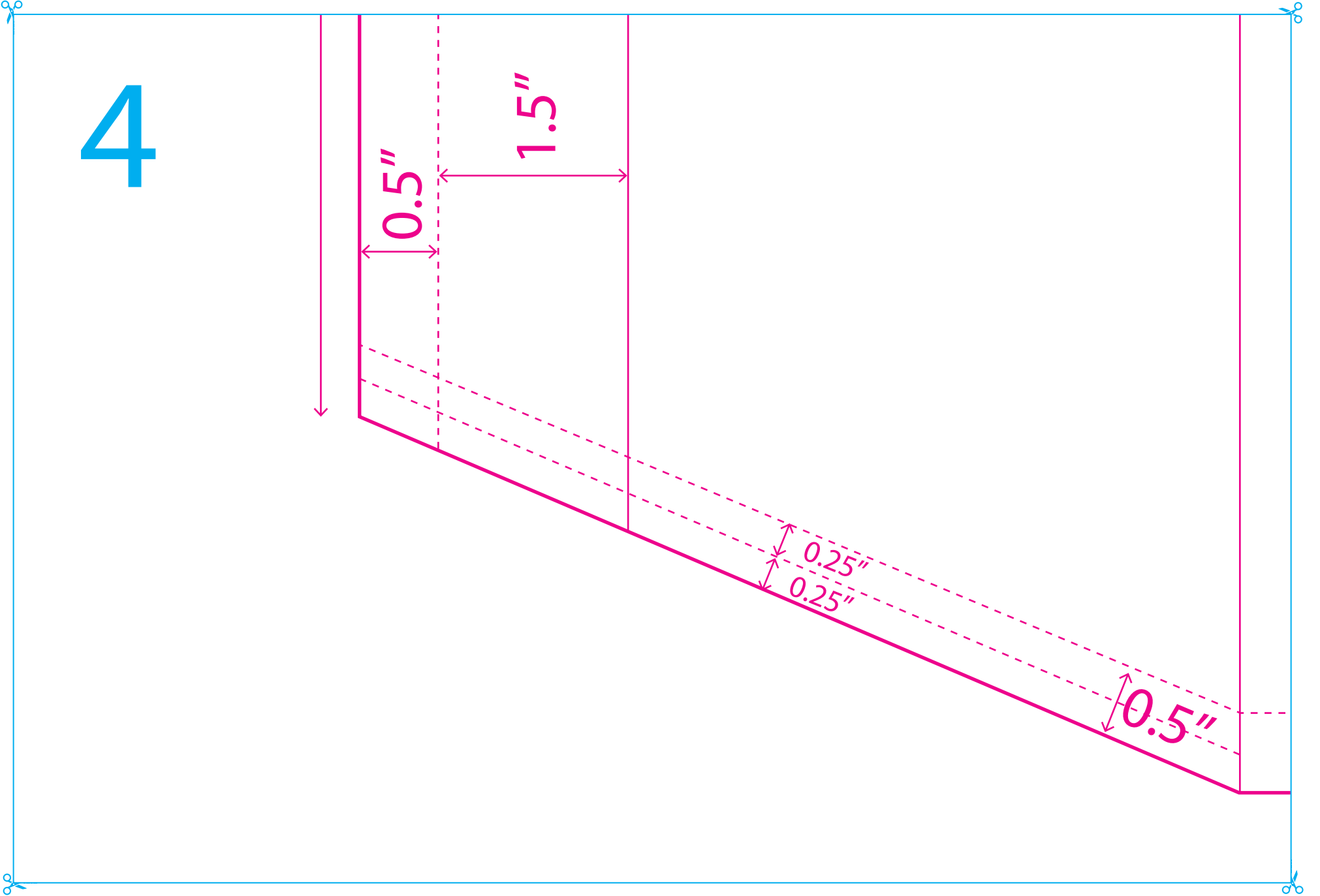

5

Size - 8 to 9

0.5"

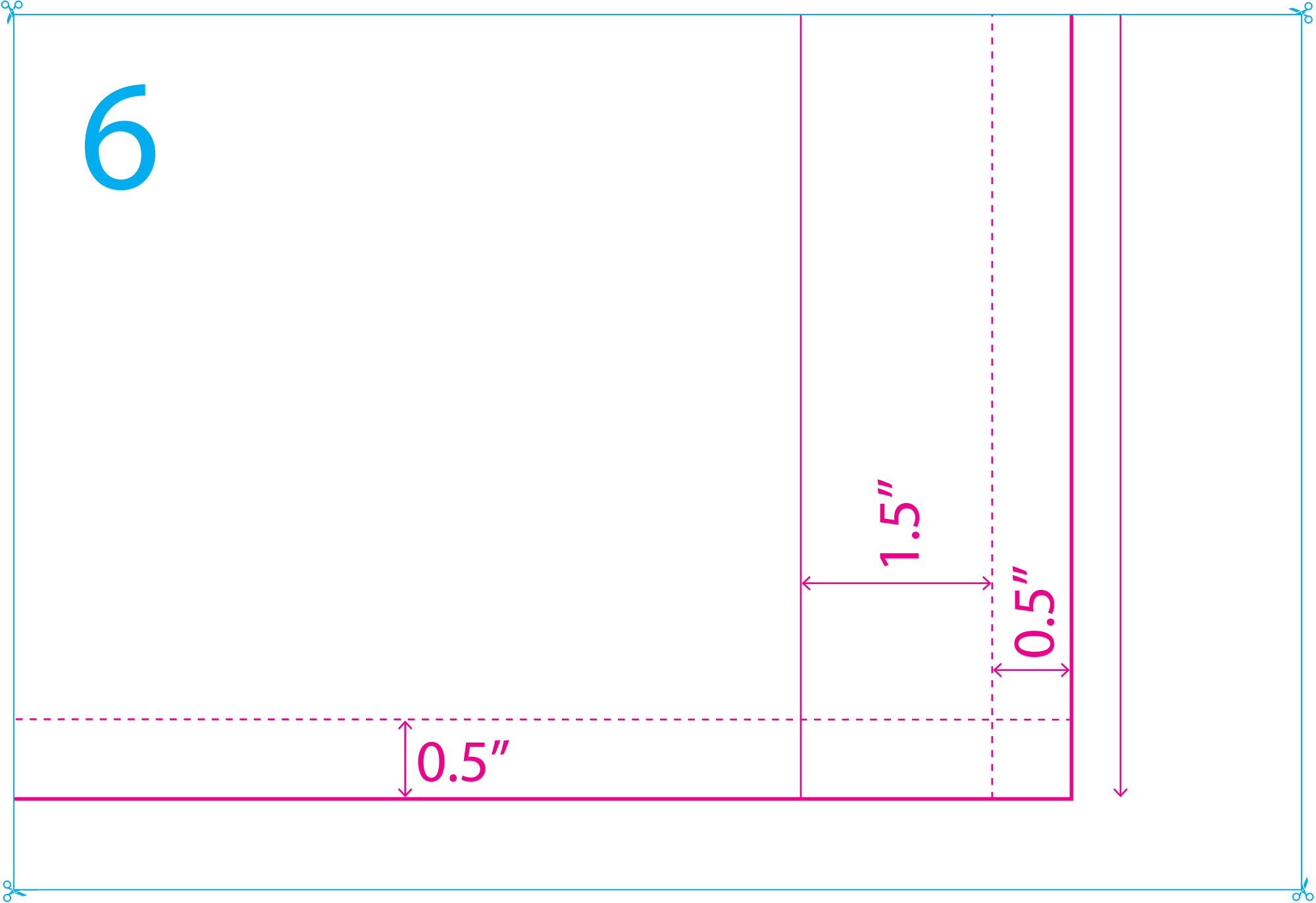

6

0.5"

1.5"

0.5"