

## Draft Instructions

Please follow the following steps in order to get the correct draft

- Download the PDF and Print it out on A4 size Paper.
- Ensure that your Printer is set to General and Page Position is Centered.

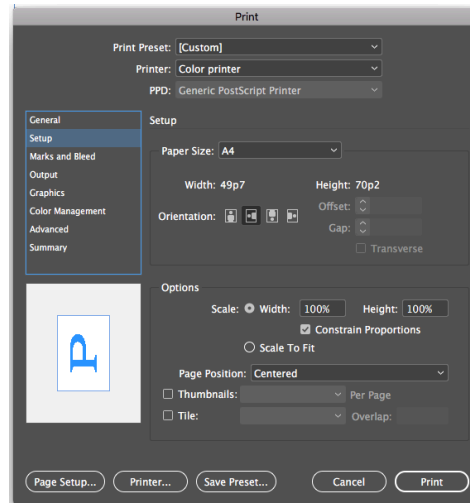
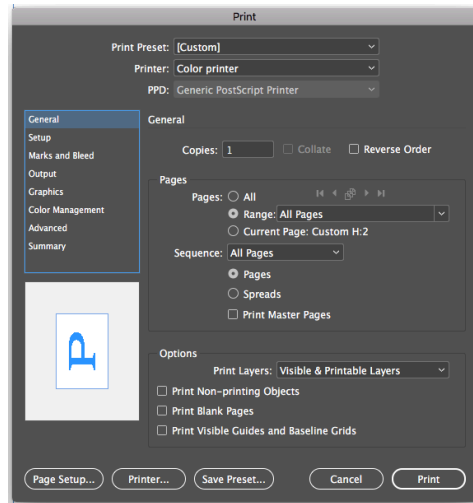

- Cut along the outer margins printed on the sheets
- Join the sheets together following the number pattern on them, as shown in the reference image below
- Your Draft is Ready

## Size Chart

Womens Size / Measurements	XS	S	M	L	XL
Skirt length	15"	16.5"	17"	18"	18.5"
Waist round	24.5"	26"	29"	31.5"	33.5"
Hip round	33.5"	34.5"	36.5"	39.5"	41.5"

1

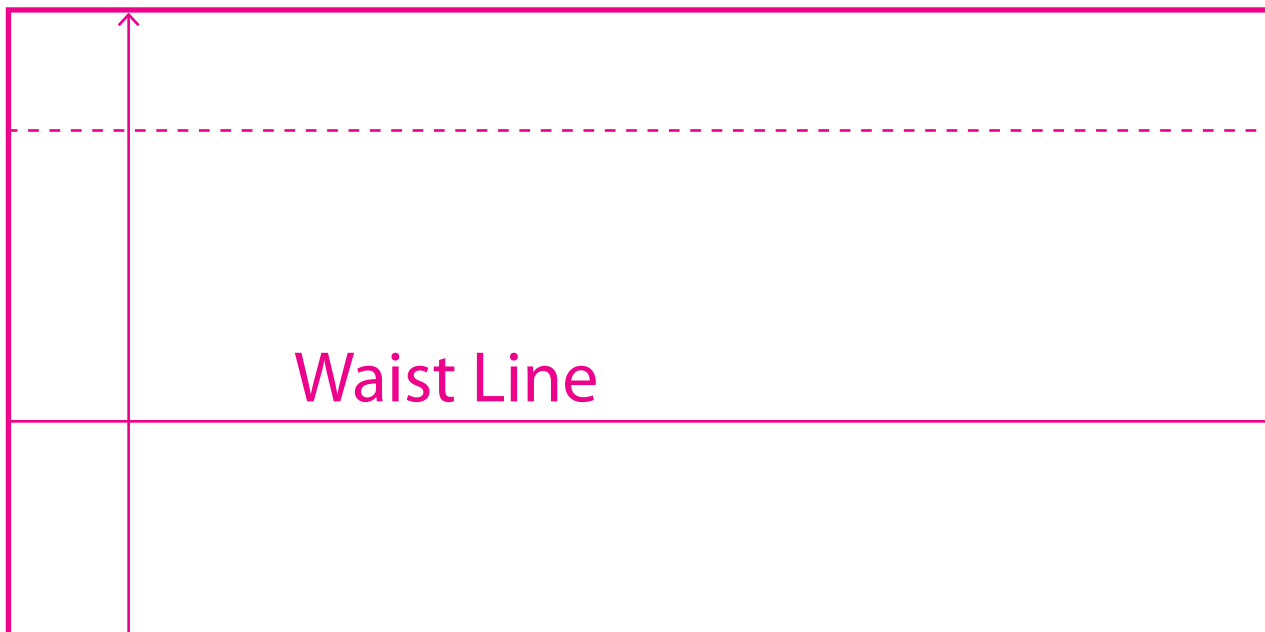



2

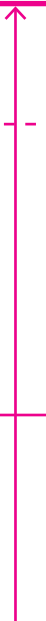

3

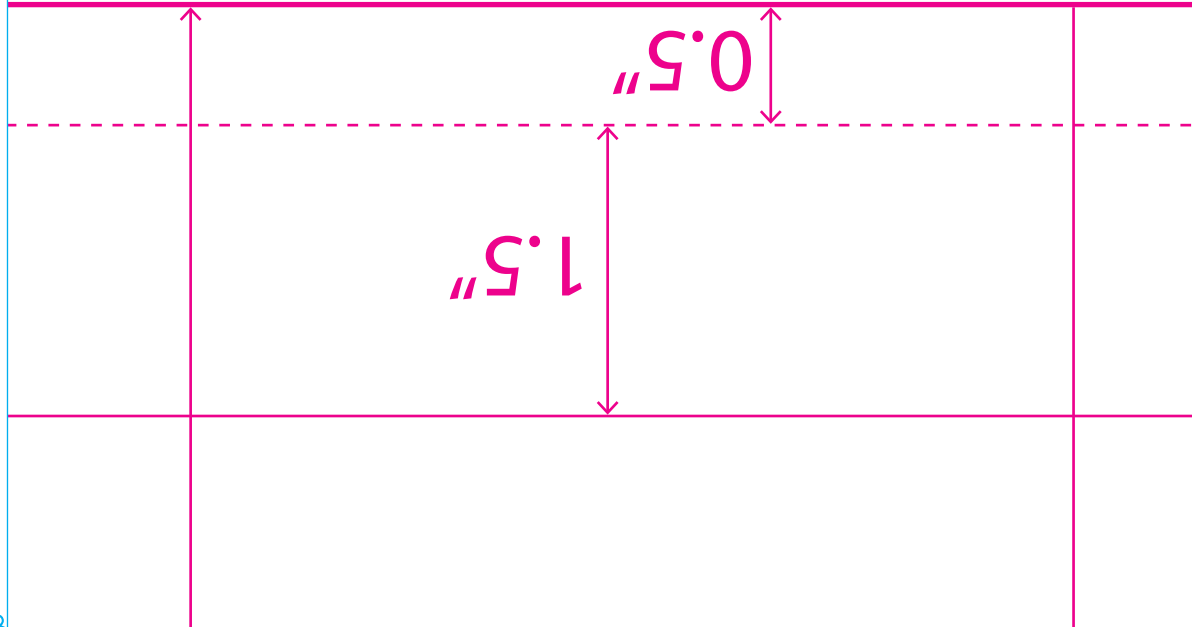

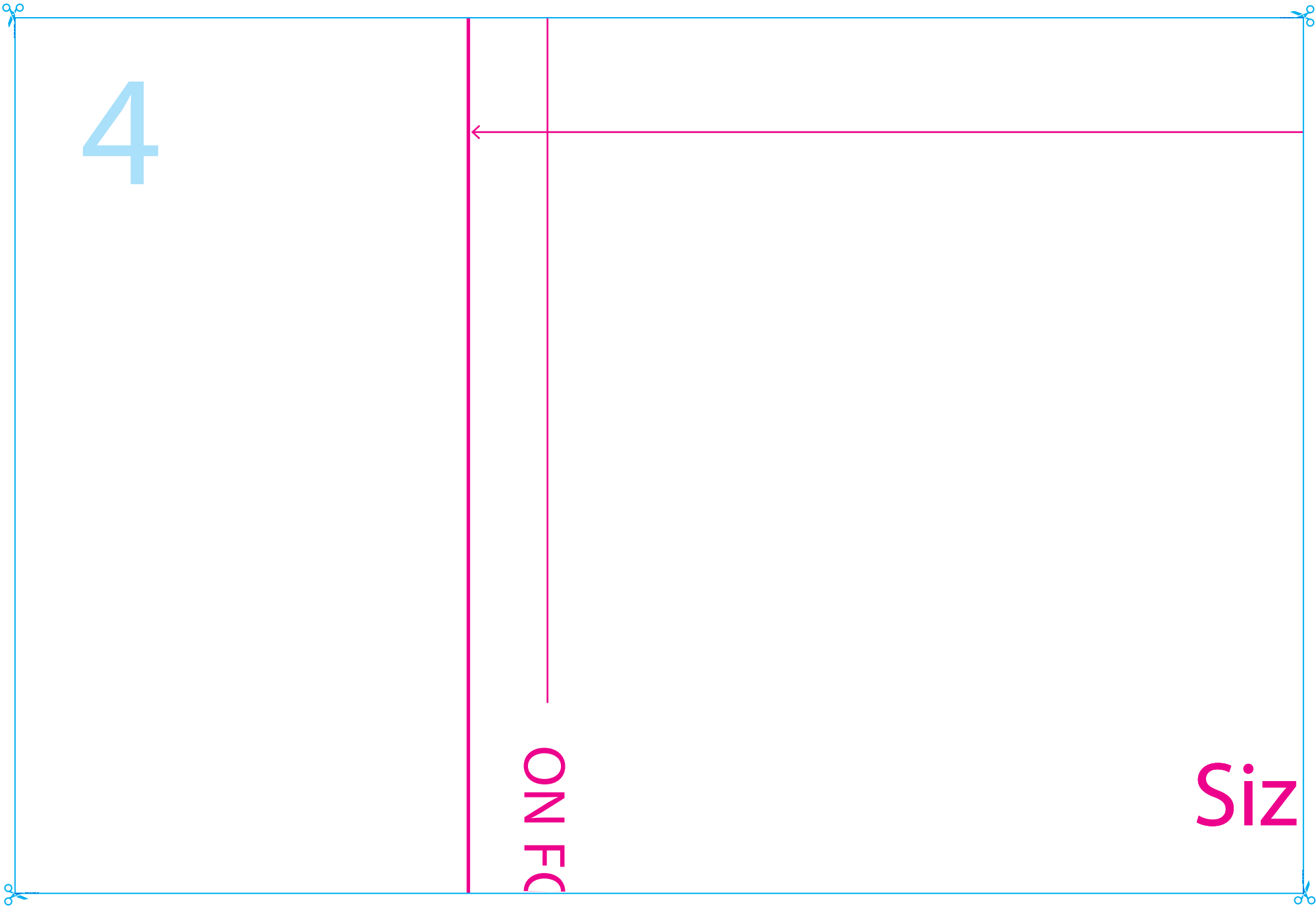

4

ONFC

Siz



5

23"

20"

Skirt

e - 7 Small Size

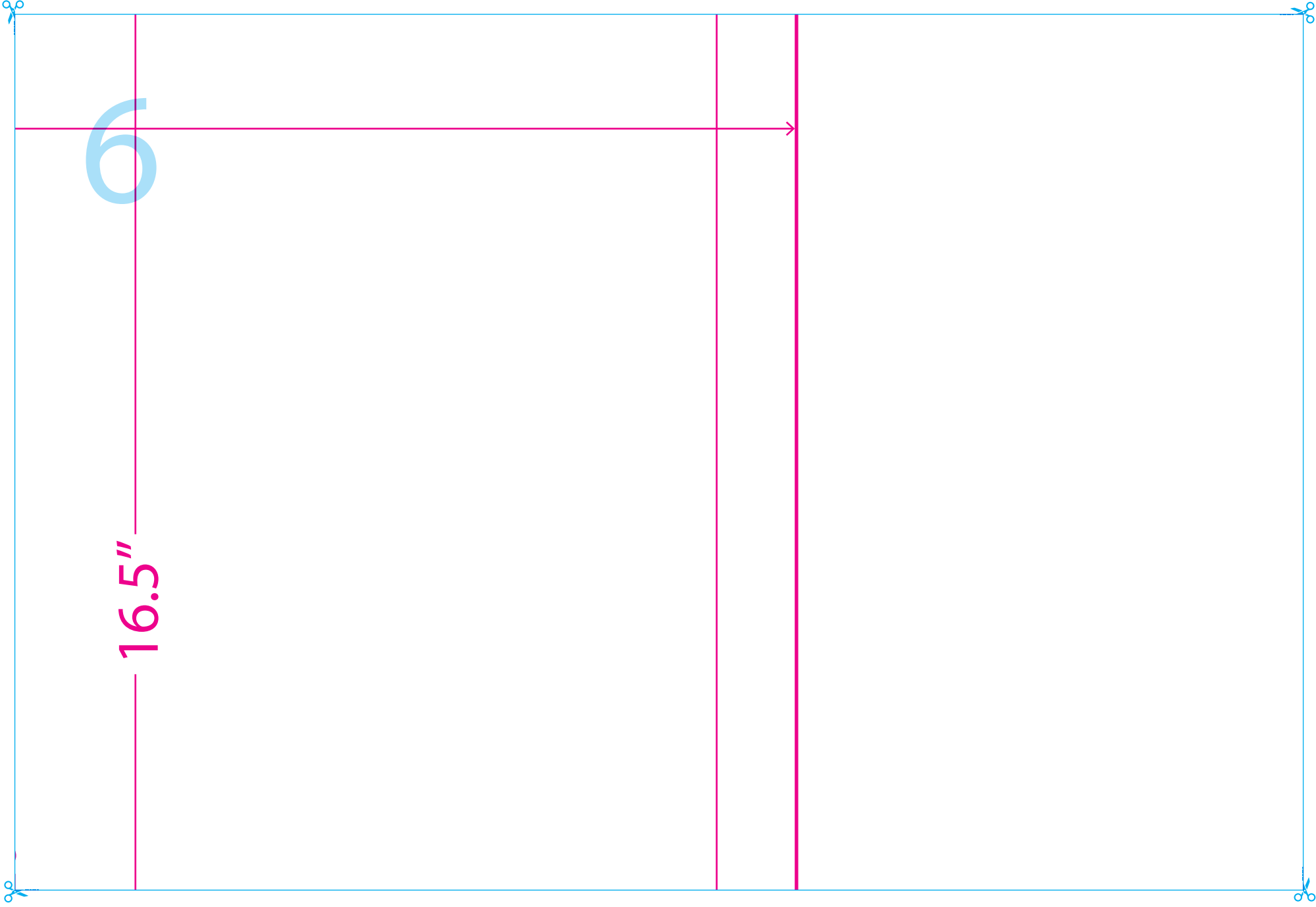



7

DLD

Hem Level

Layered Skirt - 1

8

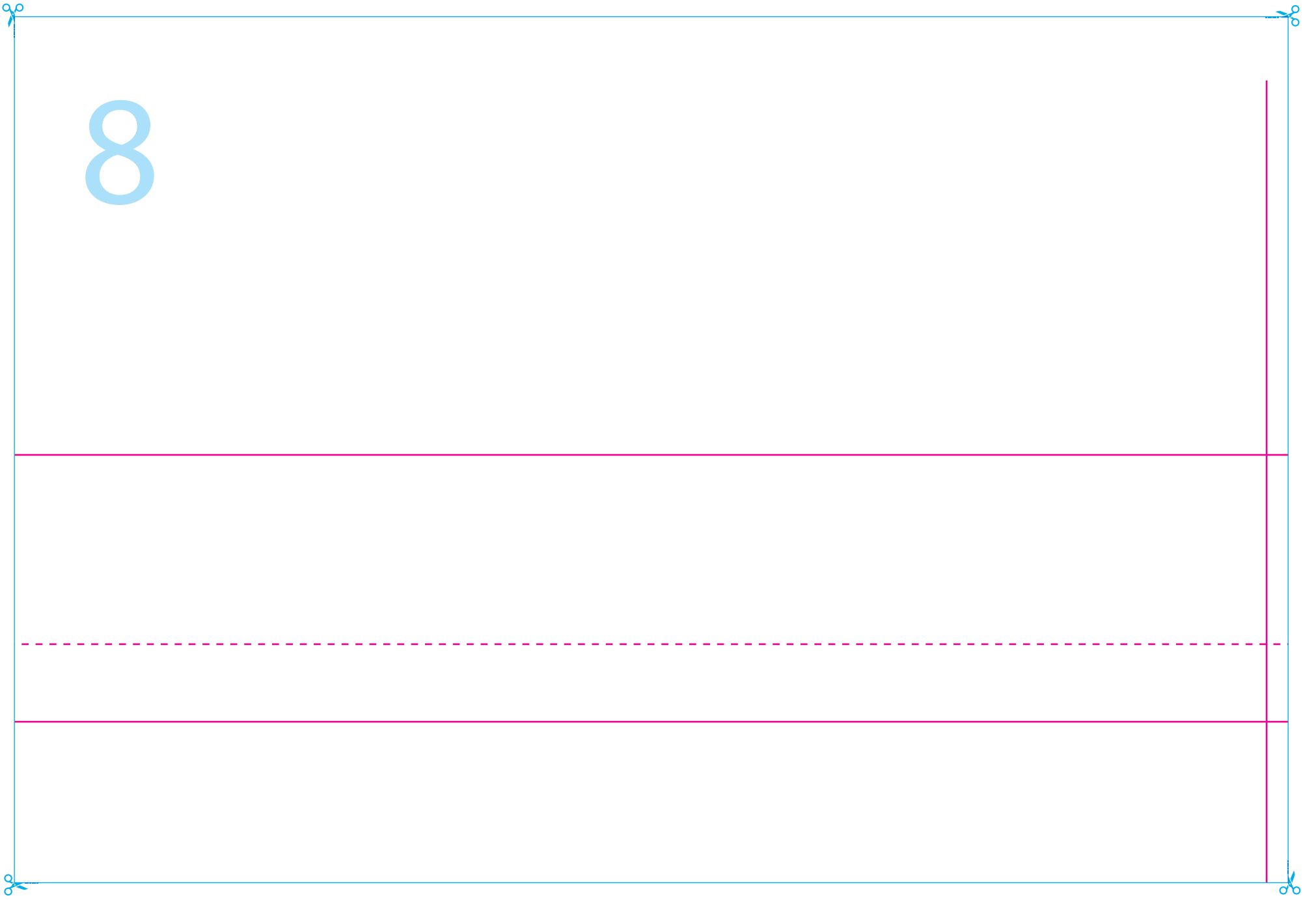

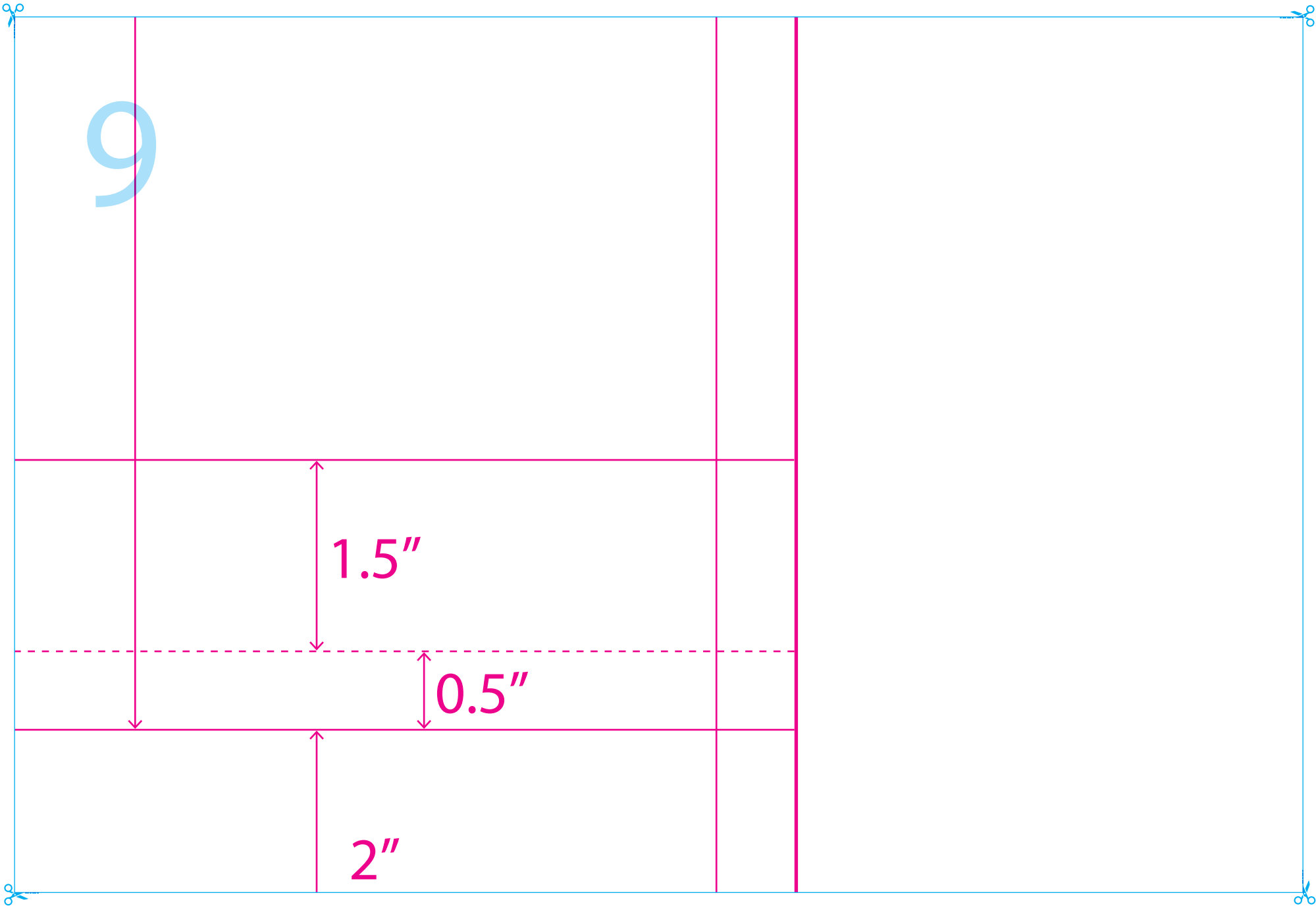

10

Hem Level

Layered Skirt - 2



