

Draft Instructions

Please follow the following steps in order to get the correct draft

- Download the PDF and Print it out on A4 size Paper.
- Ensure that your Printer is set to General and Page Position is Centered.
- Cut along the outer margins printed on the sheets
- Join the sheets together following the number pattern on them, as shown in the reference image below
- Your Draft is Ready

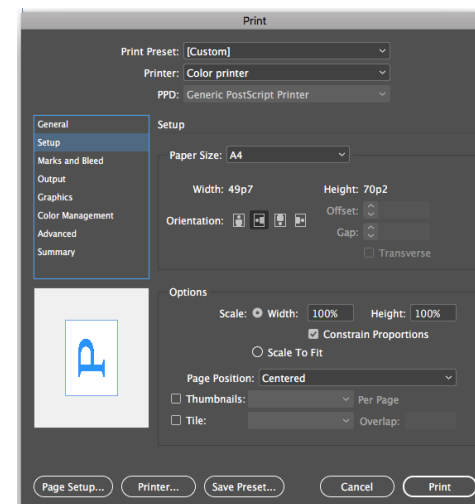
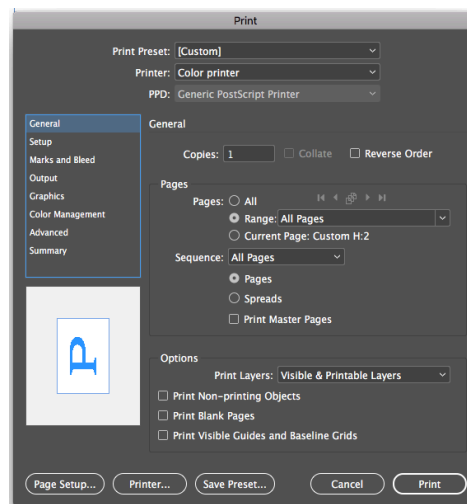

Size Chart

Size / Measurements	XS	S	M	L	XI
Pants length with casing & hem allowance	42.5"	43.25"	44.5"	44.5"	44.75"
Ready Waist round	27"	29"	30"	32"	34"
Ready Hip round	33.5"	34.5"	36.5"	39.5"	14.5"
Template Waist round	20.75"	21.25"	22.75"	24"	24.75"
Side seam allowance included in the pattern	0.5"	0.5"	0.5"	0.5"	0.5"
Crotch depth (on the centre line)	12.5"	12.75"	13.50"	14"	14.5"
Crotch Level across Front including side allowance	12.25"	12.5"	13.5"	14"	14.5"
Crotch Level across Back including side allowance	12.75"	13"	13.75"	14.5"	15"
Total Hem width including side allowance	17"	18"	18.75"	20.25"	21.25"
Hem - first fold	0.5"	0.5"	0.5"	0.5"	0.5"
Hem - second fold	1.5"	1"	1"	1"	1"
Casing - first fold	0.5"	0.5"	0.5"	0.5"	0.5"
Casing - second fold	1.5"	1.5"	1.5"	1.5"	1.5"

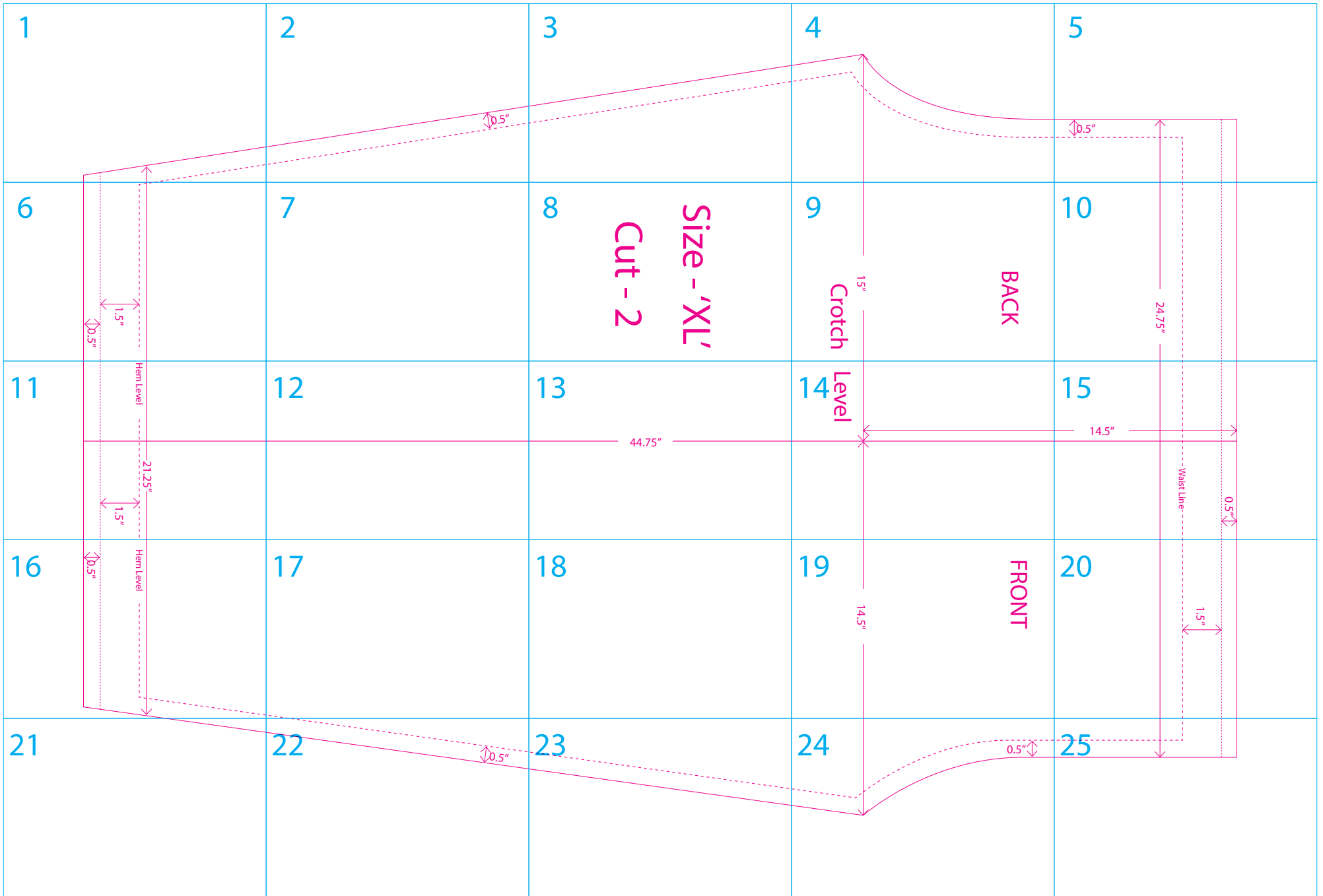

1

2

3

4

5

6

7

8

9

10

11

12

13

14

15

16

17

18

19

20

21

22

23

24

25

Size - 'XL'
Cut - 2

BACK

FRONT

Crotch
Level

Waist Line

Hem Level

Hem Level

0.5"

0.5"

0.5"

1.5"

1.5"

0.5"

44.75"

14.5"

24.75"

0.5"

1.5"

15"

14.5"

0.5"

0.5"

1

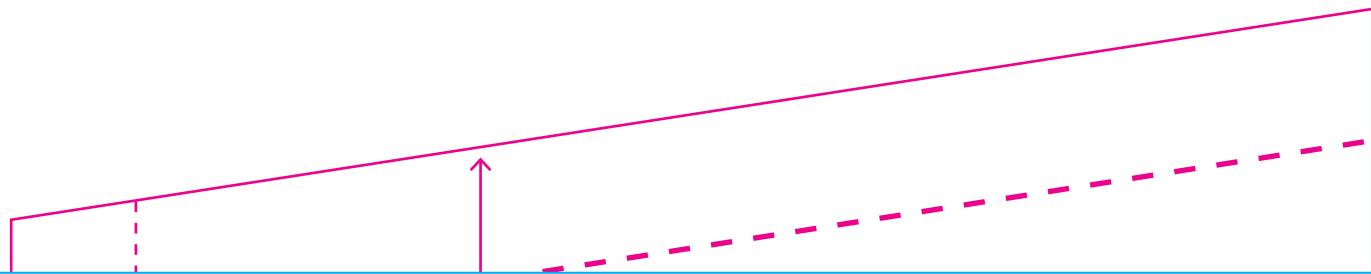

2

0.5"



3

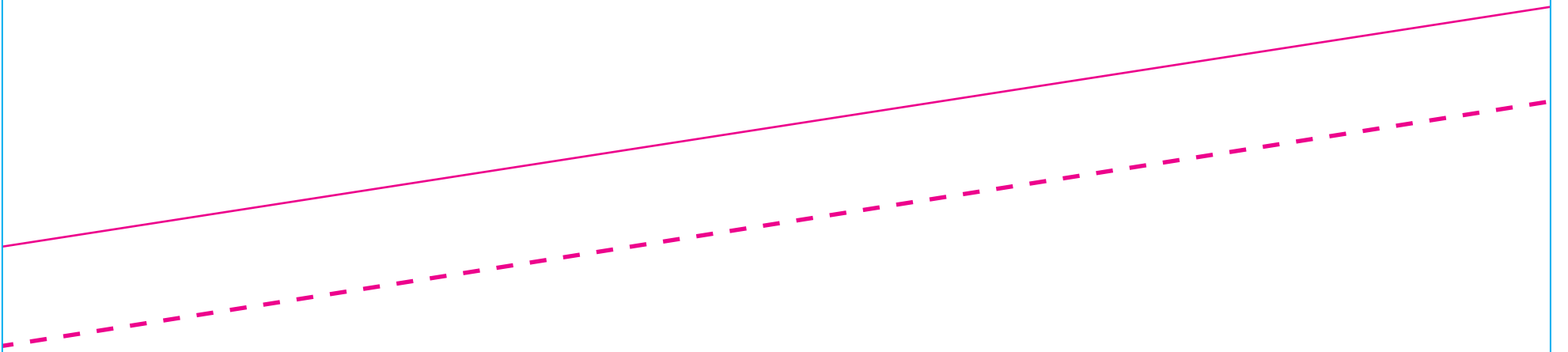



4

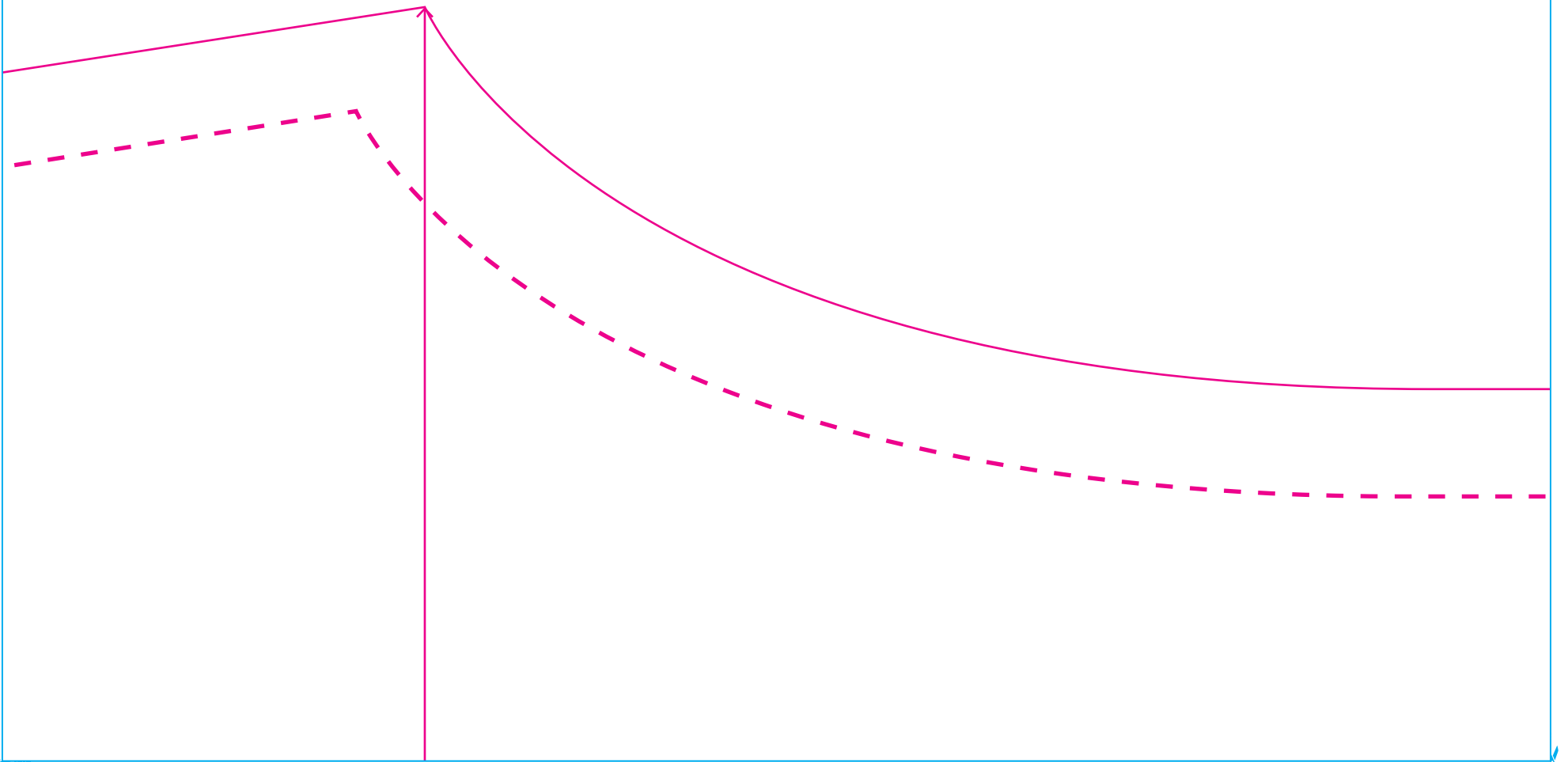



5



0.5"

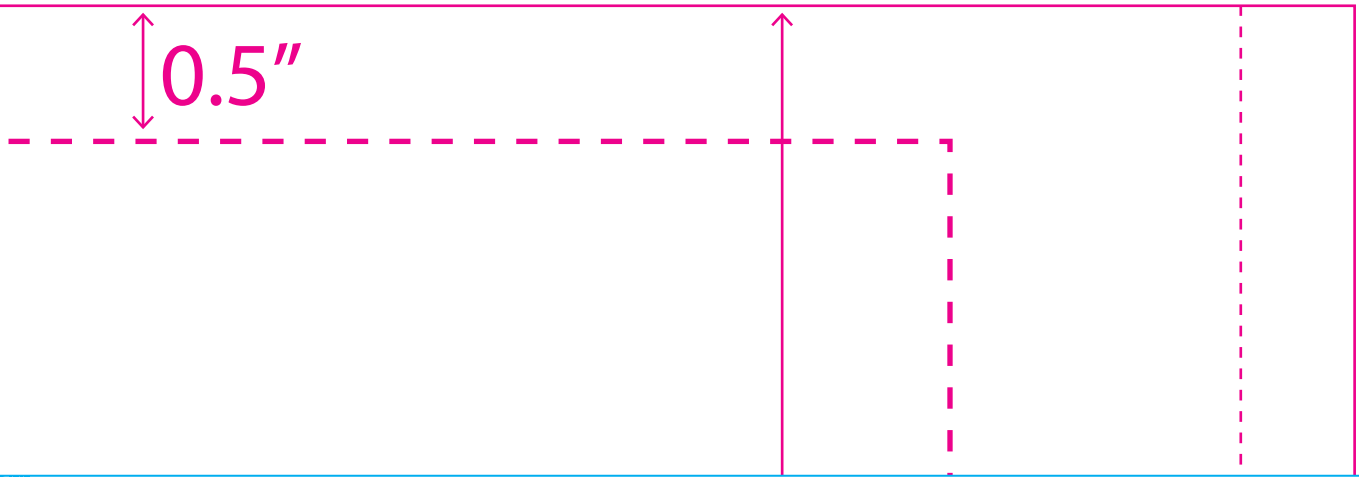

6

0.5"

1.5"



7

Size - 'XL'

Cut - 2

8

BACK

15"

Crotch

6

10

24.75"



11

Hem Level

21.25"

1.5"



12

13

44.75"

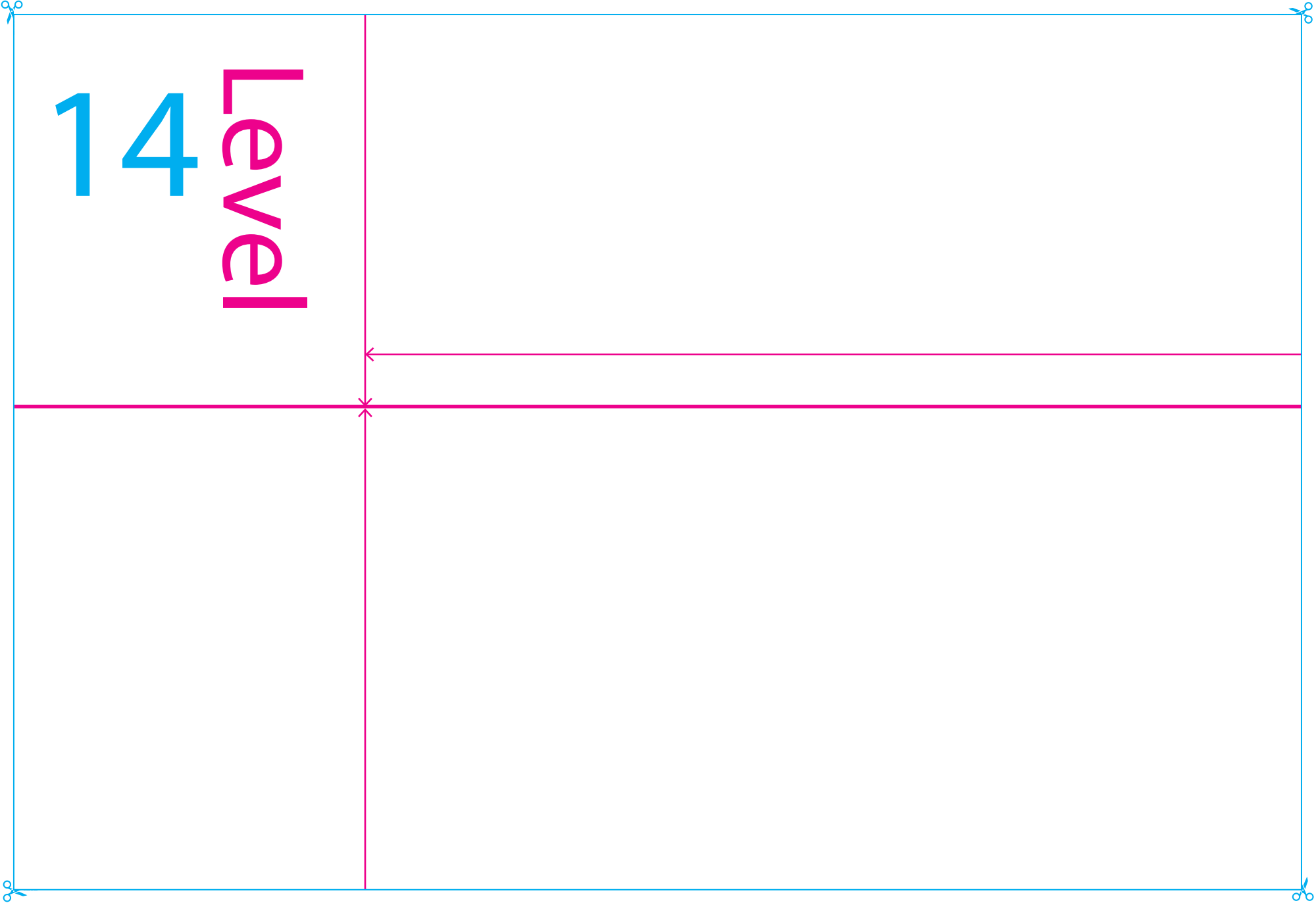

14
Level

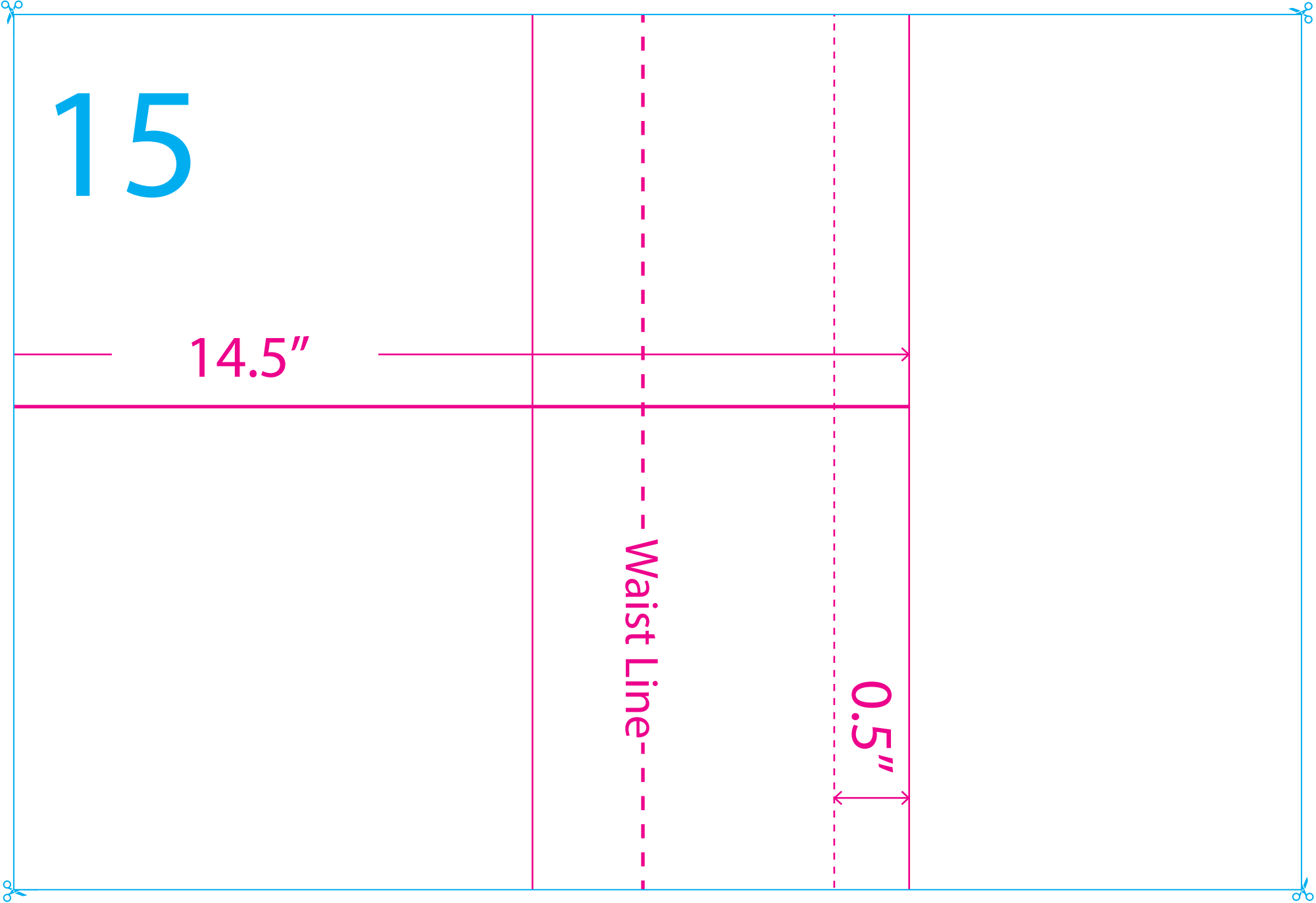

16

0.5"

Hem Level

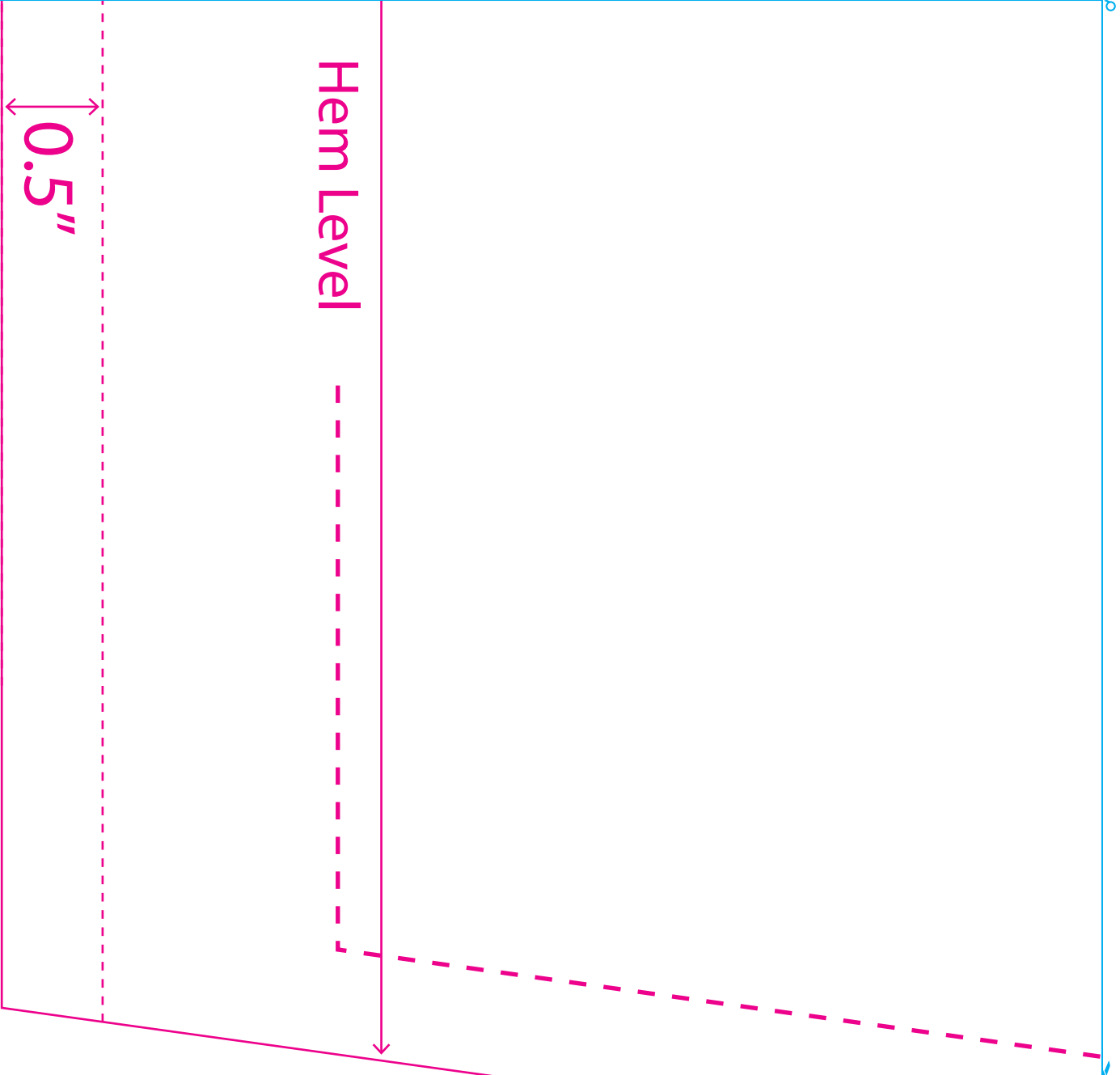



17





18

FRONT

14.5"

19

20

1.5"



21



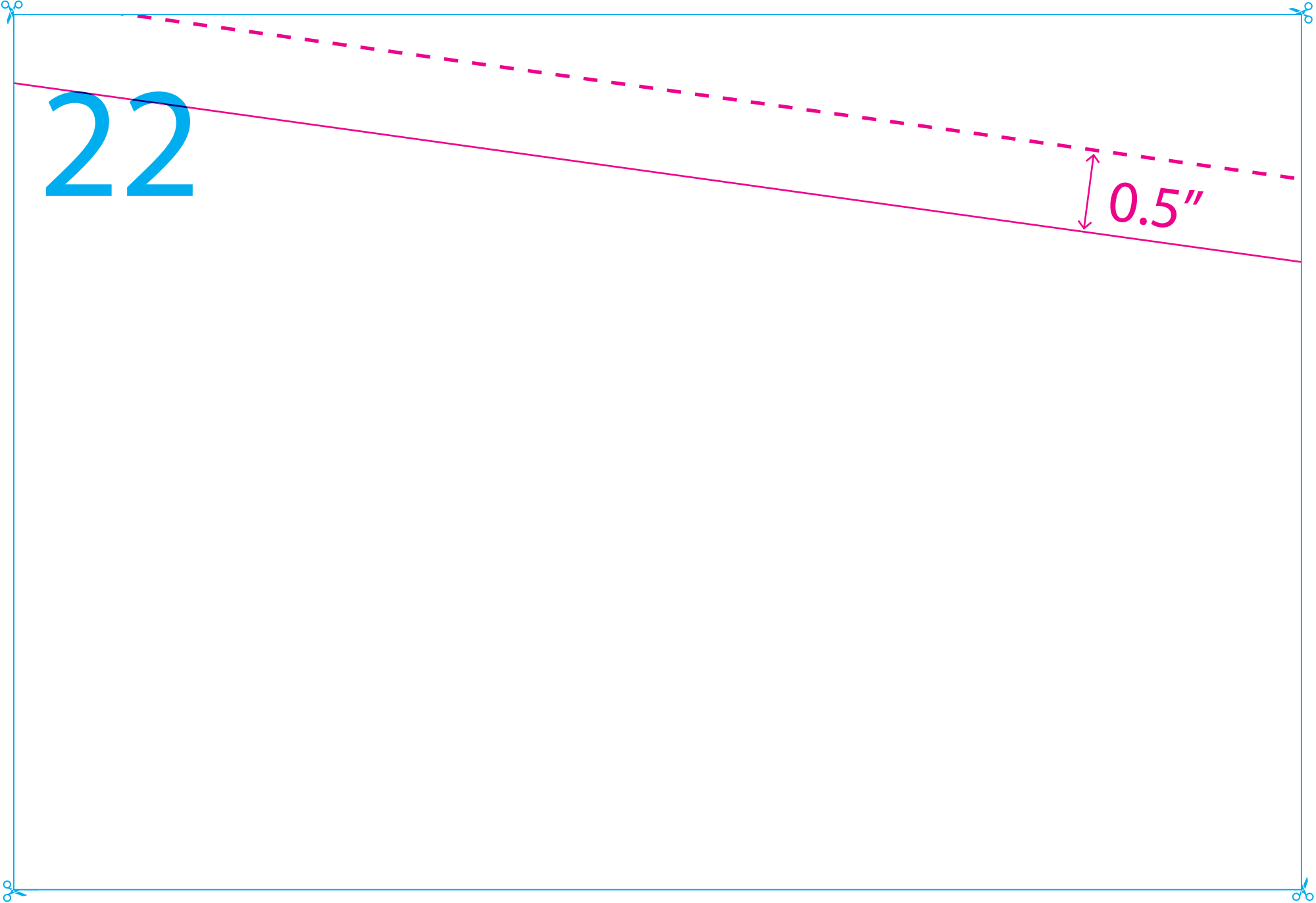

22

0.5"

23





24

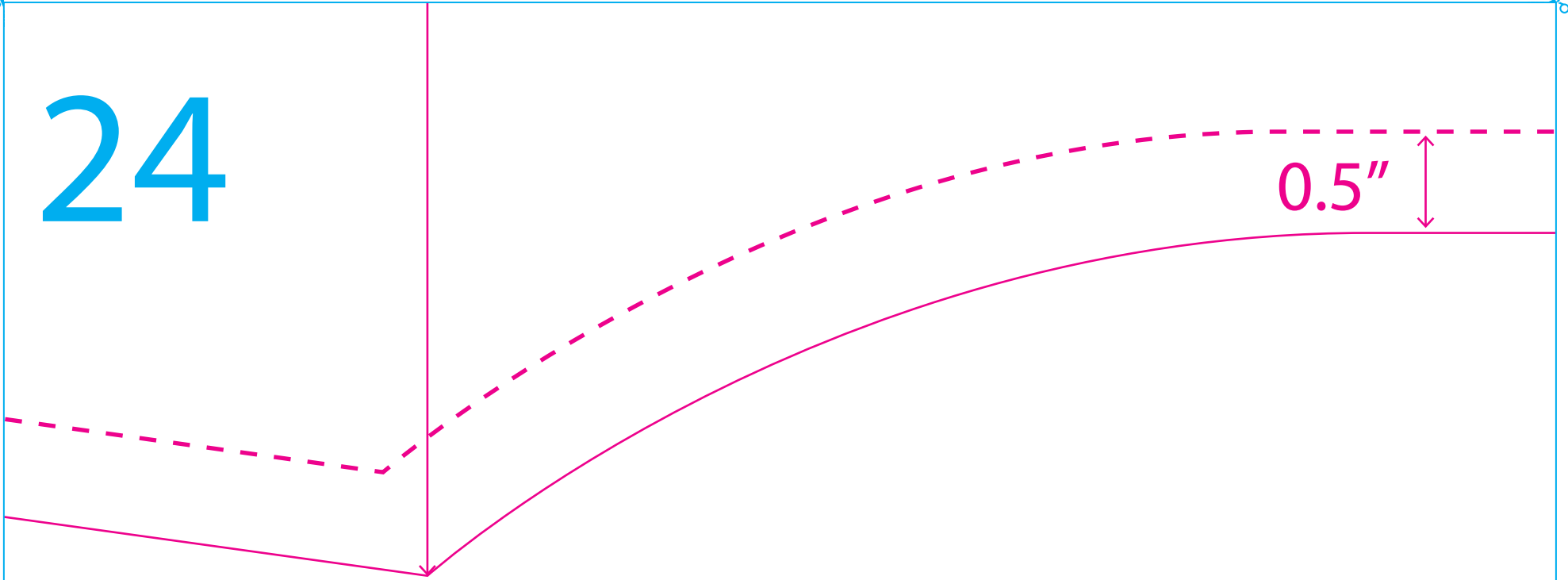

0.5"





25

