

# INDEX

## (TUNIC TOP – Large)

• INDEX	Pg 1
• DRAFT INSTRUCTIONS	Pg 2
• TEMPLATES 1	Pg 3
• TEMPLATES 2	Pg 4
• TEMPLATES 1A	Pg 5
• TEMPLATES 1B	Pg 6
• TEMPLATES 1C	Pg 7
• TEMPLATES 1D	Pg 8
• TEMPLATES 1E	Pg 9
• TEMPLATES 1F	Pg 10
• TEMPLATES 1G	Pg 11
• TEMPLATES 1H	Pg 12
• TEMPLATES 1I	Pg 13
• TEMPLATES 1J	Pg 14
• TEMPLATES 1K	Pg 15
• TEMPLATES 1L	Pg 16
• TEMPLATES 2A	Pg 17
• TEMPLATES 2B	Pg 18
• TEMPLATES 2C	Pg 19
• TEMPLATES 2D	Pg 20
• TEMPLATES 2E	Pg 21
• TEMPLATES 2F	Pg 22
• TEMPLATES 2G	Pg 23
• TEMPLATES 2H	Pg 24
• TEMPLATES 2I	Pg 25
• TEMPLATES 2J	Pg 26
• TEMPLATES 2K	Pg 27
• TEMPLATES 2L	Pg 28

**DRAFT INSTRUCTIONS**

**PLEASE FOLLOW THE FOLLOWING STEPS IN ORDER TO GET THE CORRECT DRAFT**

1. Download the PDF and print it out on A4 size paper
2. Ensure that your Printer is set to General and Page Position is Centered
3. Please select Print Actual Size option in the Printer Setup
4. To stick the Pattern - Cut along the outer margins (Blue) printed on the sheet as and when required
5. Join the sheets together following the Number Pattern on them as shown in the full pattern templates below
6. Cut along the Dotted Line for the Final Pattern -----
7. Your Draft is ready

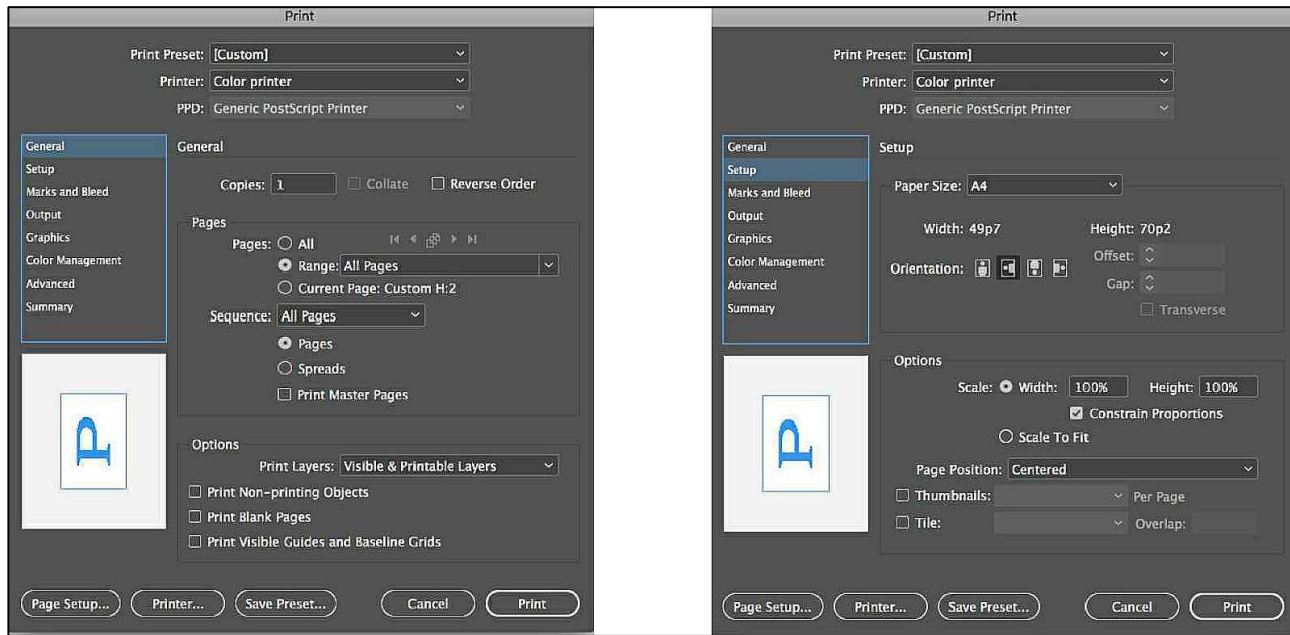

**TUNIC TOP - Size Chart**

Measurements	Front ( cm )	Back ( cm )	Front ( cm )	Back ( cm )	Front ( cm )	Back ( cm )	Front ( cm )	Back ( cm )	Front ( cm )	Back ( cm )
	XS	XS	S	S	M	M	L	L	XL	XL
Ready top Length	72.4	72.4	74.3	74.3	74.9	74.9	76.2	76.2	77.5	77.5
Neck depth	7.6	2.5	8.3	2.5	8.3	2.5	8.9	2.5	9.2	2.5
neck width	7.6	7.6	7.6	7.6	8.3	8.3	8.3	8.3	9.5	9.5
Shoulder to chest	21.6	21.6	22.9	22.86	23.5	23.5	24.8	24.8	25.4	25.4
Neckline to chest	14.0	19.1	14.6	20.3	15.2	21.0	15.9	22.2	16.2	22.9
Chestline to hemline	50.8	50.8	51.4	51.4	51.4	51.4	51.4	51.4	52.1	52.1
Across shoulder	31.8	31.8	31.8	31.8	32.4	32.4	33.7	33.7	34.3	34.3
Shoulder line	24.1	24.1	24.1	24.1	24.1	24.1	24.8	24.8	24.8	24.8
Across chest	25.6	25.5	25.4	25.4	26.2	26.2	27.3	27.3	28.0	28.0
shoulder drop	3.8	3.8	3.8	3.8	3.8	3.8	3.8	3.8	3.8	3.8
Hemline	30.5	30.5	31.1	31.1	31.8	31.8	32.4	32.4	33.0	33.0
Sleeve hemline	17.8	17.8	17.8	17.8	18.4	18.4	18.4	18.4	19.1	19.1
Hem depth	2.5	2.5	2.5	2.5	2.5	2.5	2.5	2.5	2.5	2.5
Side seam	47.0	47.0	47.6	47.6	47.6	47.6	48.3	48.3	48.3	48.3

**TUNIC TOP - Material Chart**

FABRIC & MATERIAL REQUIREMENT	XS	S	M	L	XL
Fabric - 45"	2.0 mtr	2.0 mtr	2.0 mtr	2.0 mtr	2.0 mtr
Finishing Fabric	0.25 mtr	0.25 mtr	0.25 mtr	0.25 mtr	0.25 mtr

1A

TEMPLATE 1  
ALL DIMENSIONS IN CENTIMETERS  
TUNIC TOP

FRONT  
Size: Large (L)  
Cut - 1 piece

1B

1C

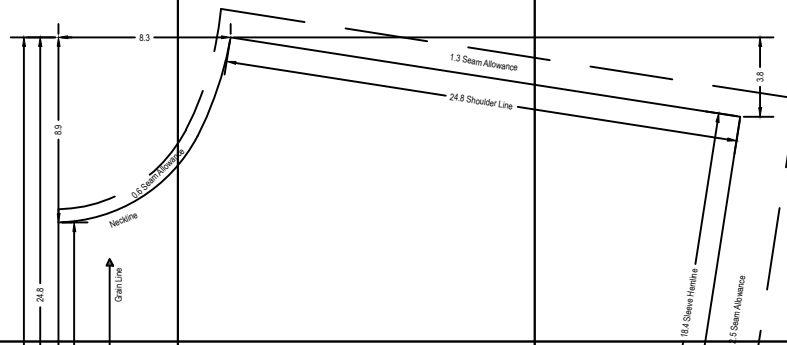

1D

1E

1F

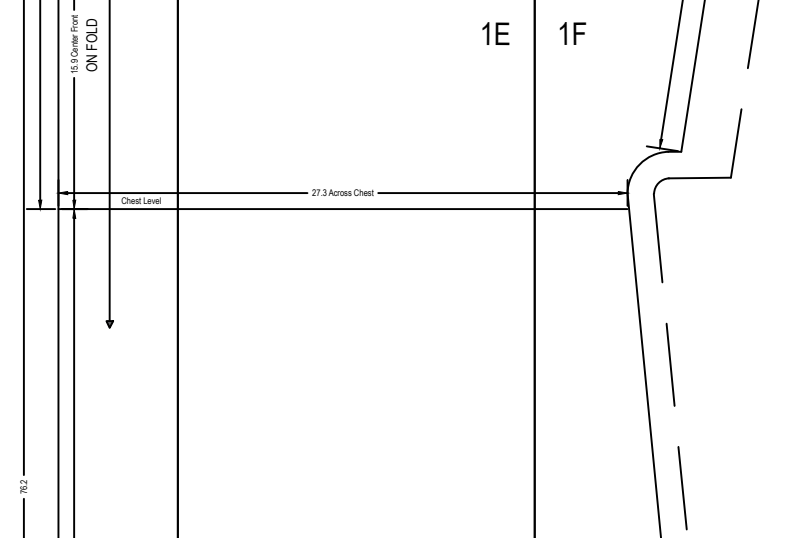

1G

1H

1I

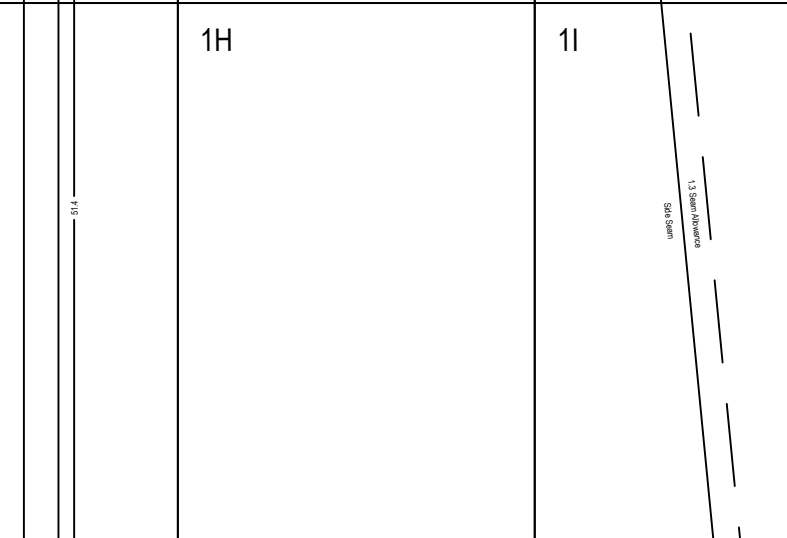

1J

1K

1L

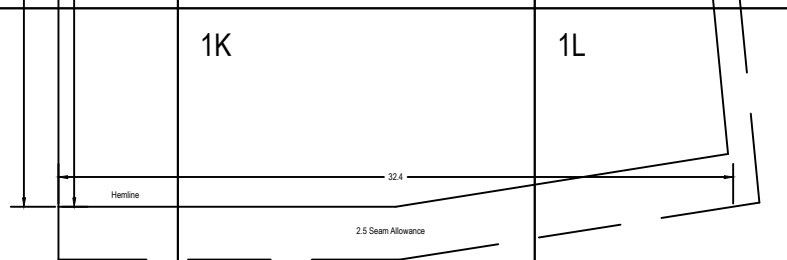

2A

TEMPLATE 2  
ALL DIMENSIONS IN CENTIMETERS  
TUNIC TOP

BACK  
Size: Large (L)  
Cut - 1 piece

2B

2C

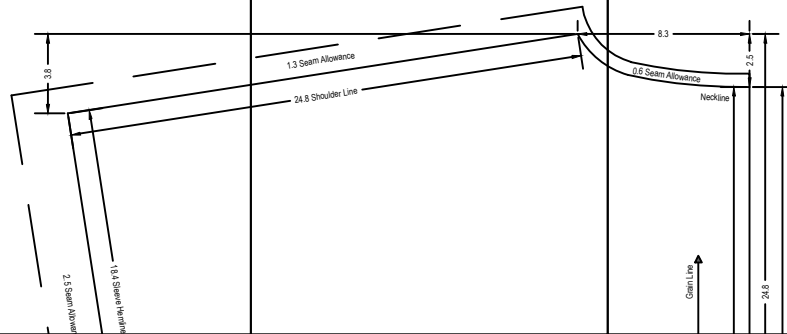

2D

2E

2F

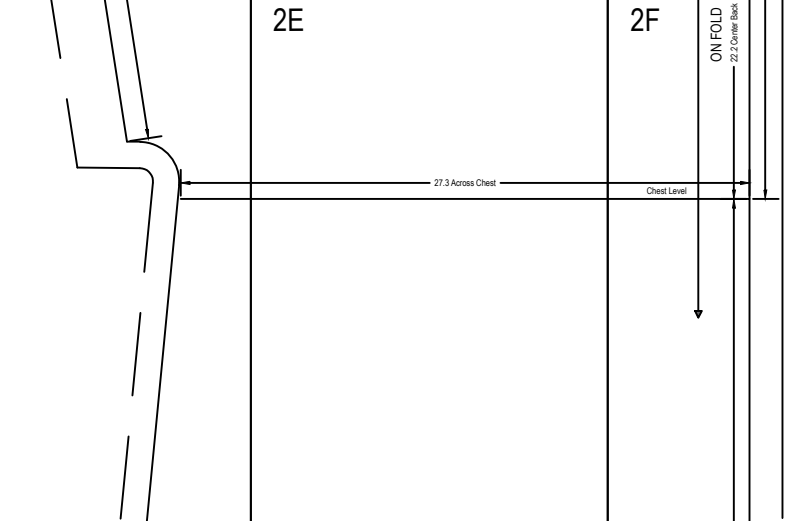

2G

2H

2I

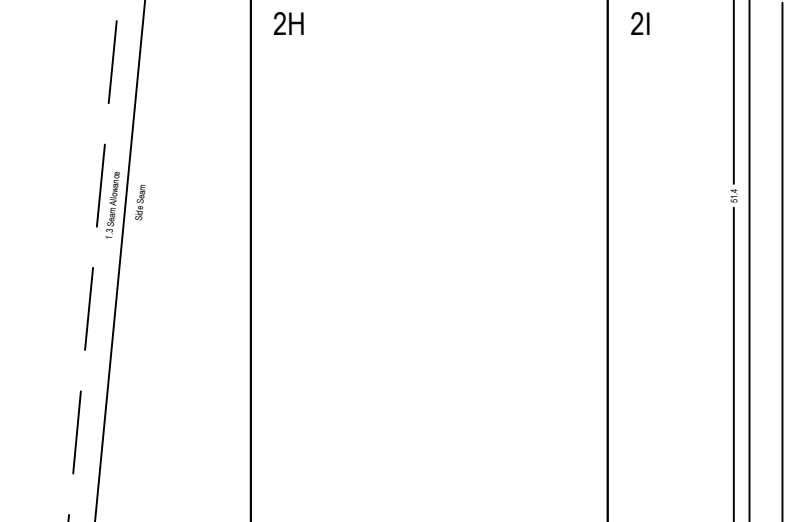

2J

2K

2L

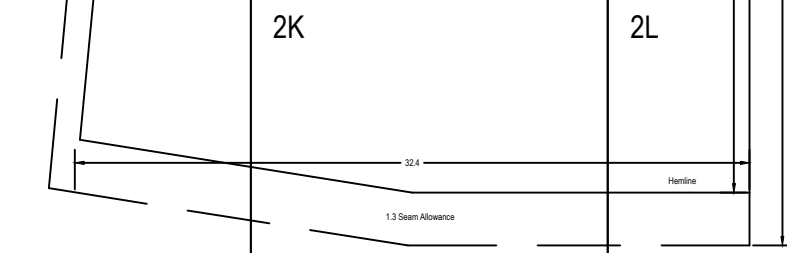

# 1A

TEMPLATE 1  
ALL DIMENSIONS IN CENTIMETERS  
TUNIC TOP

FRONT  
Size: Large (L)  
Cut - 1 piece

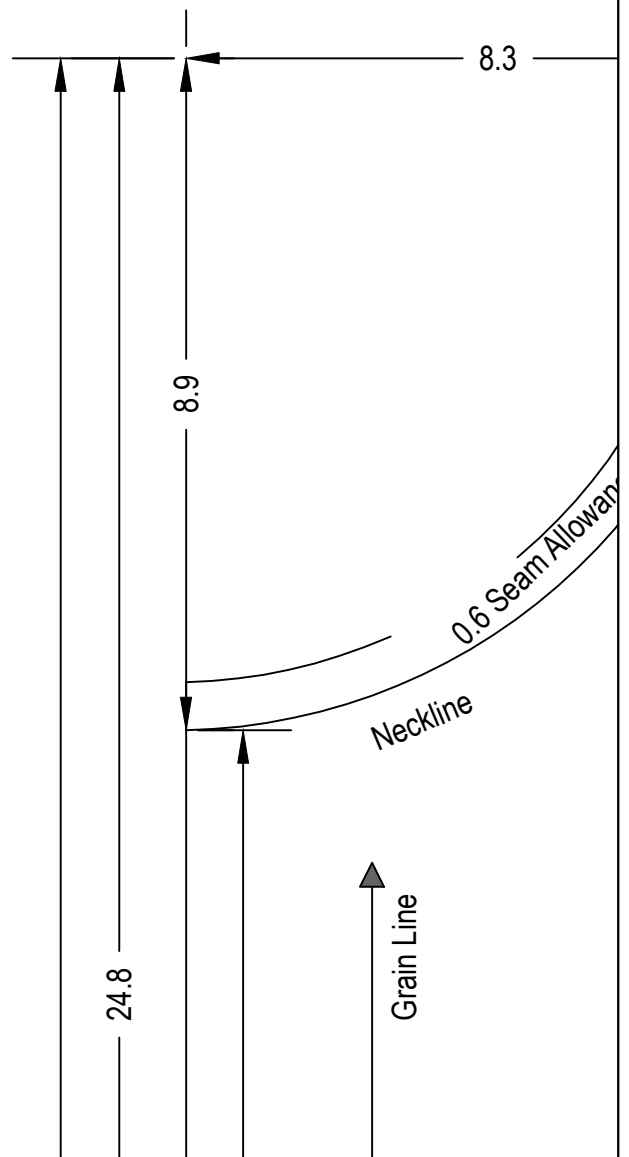

1B

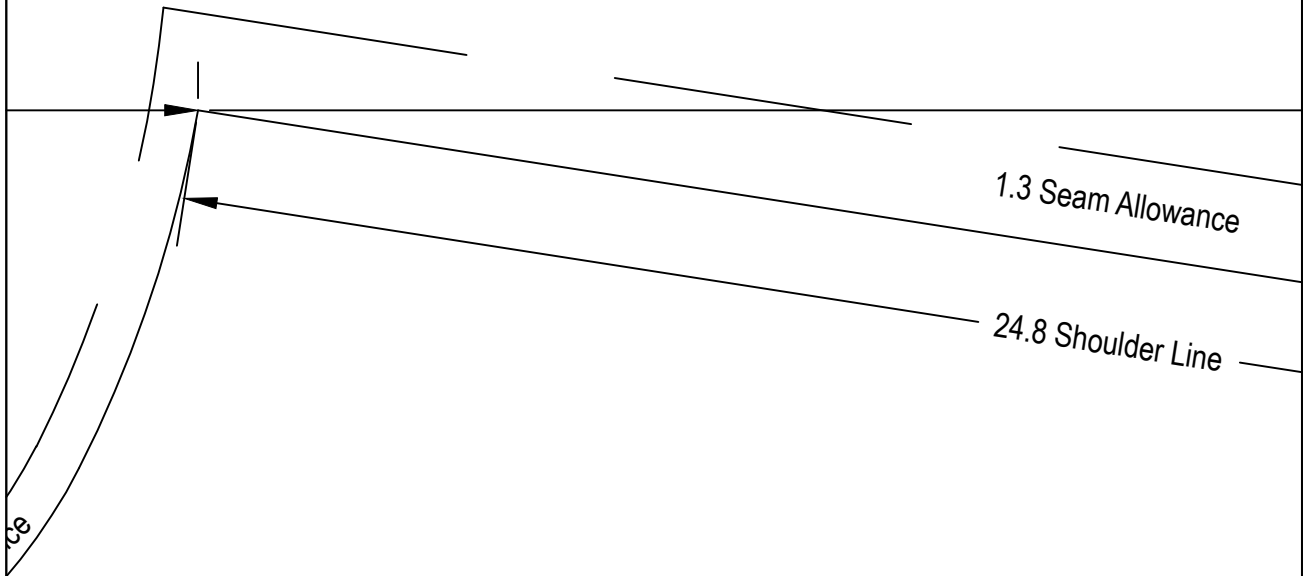

1C



1D

76.2

15.9 Center Front

ON FOLD

Chest Level

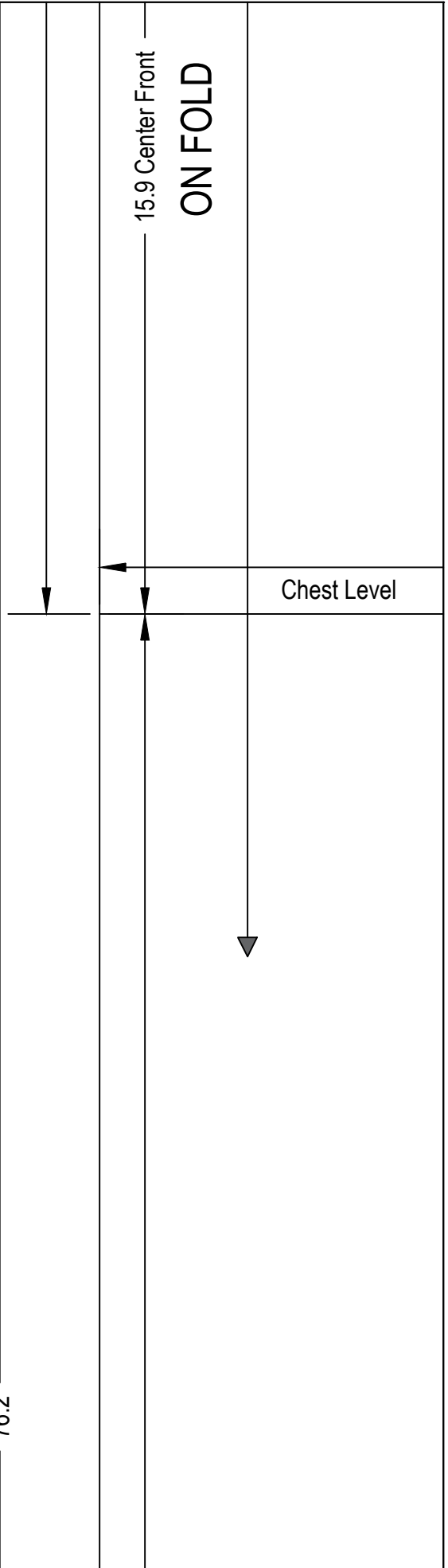



1E

27.3 Across Chest

1F

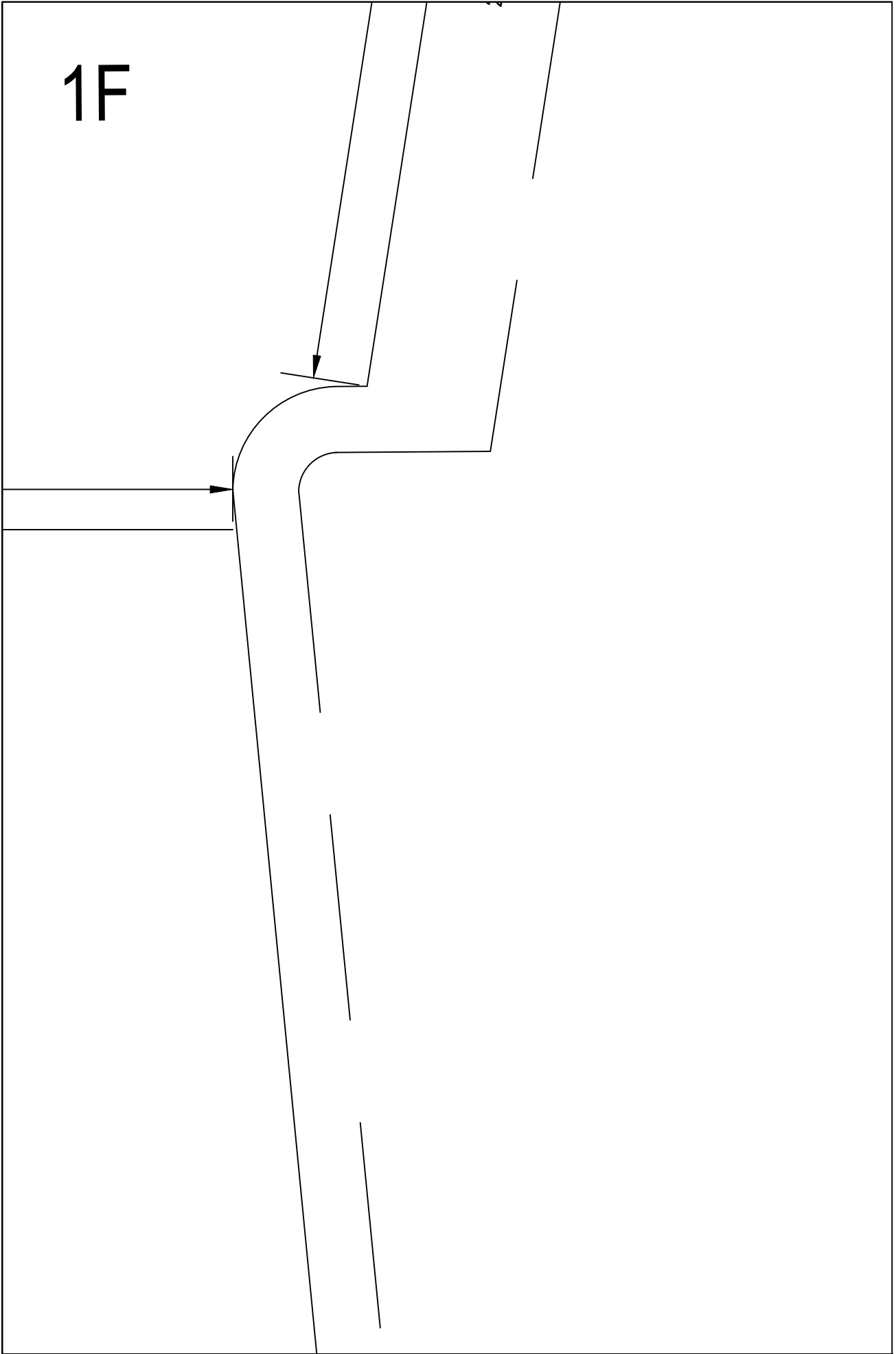

1G

51.4

1H

11

Side Seam  
1.3 Seam Allowance

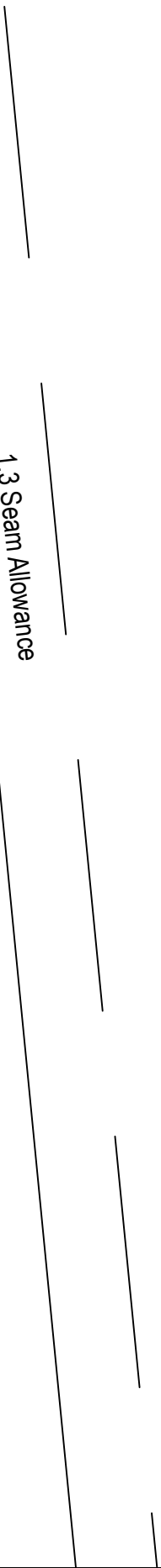

1J

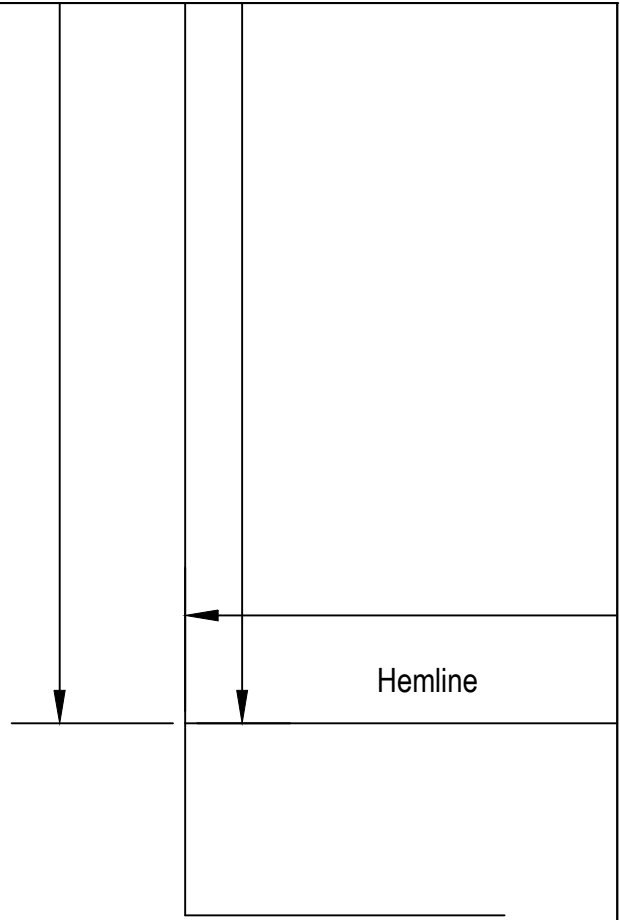

1K

32.4

2.5 Seam Allowance

1L

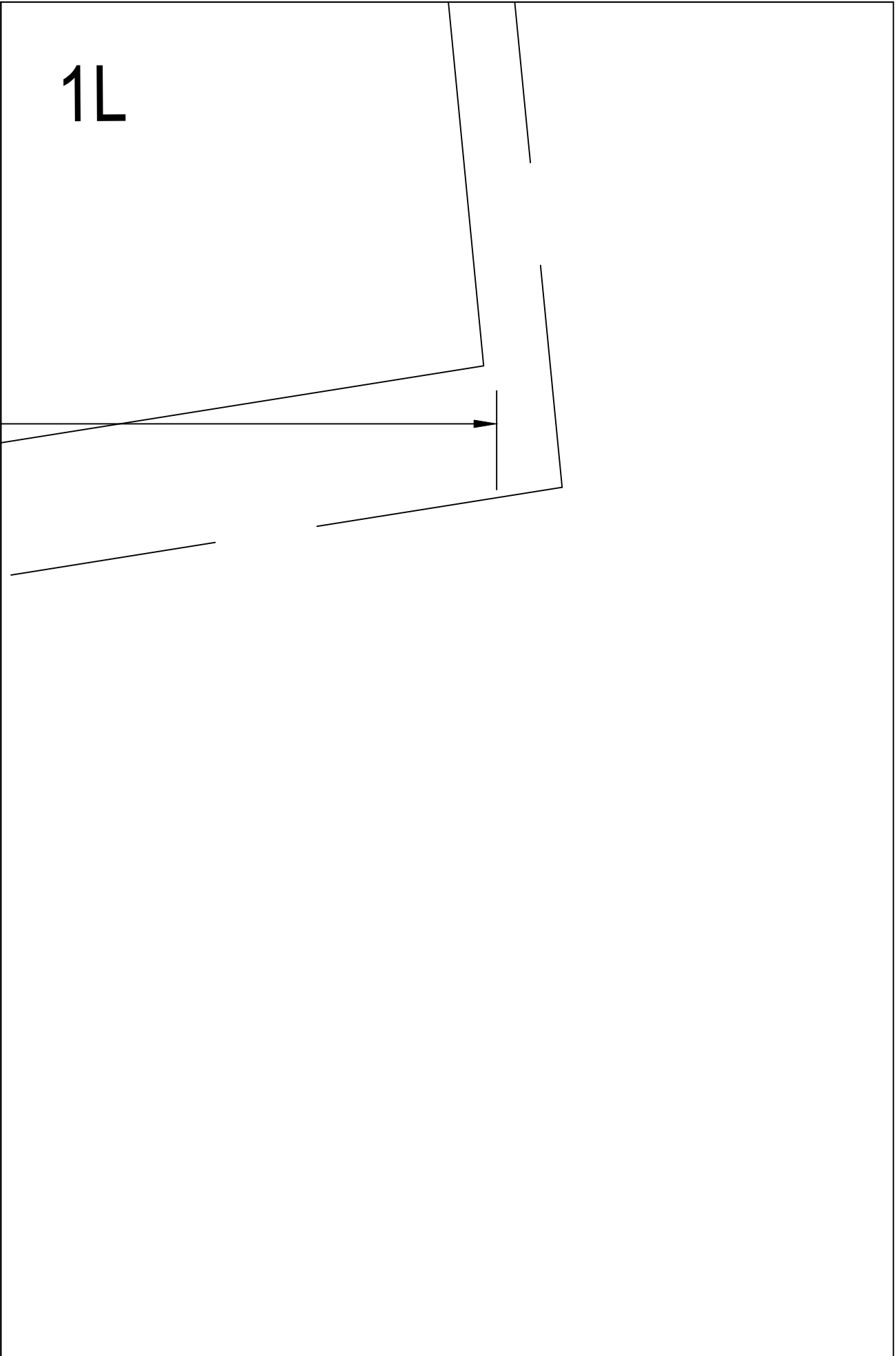



# 2A

## TEMPLATE 2 ALL DIMENSIONS IN CENTIMETERS TUNIC TOP

BACK  
Size: Large (L)  
Cut - 1 piece

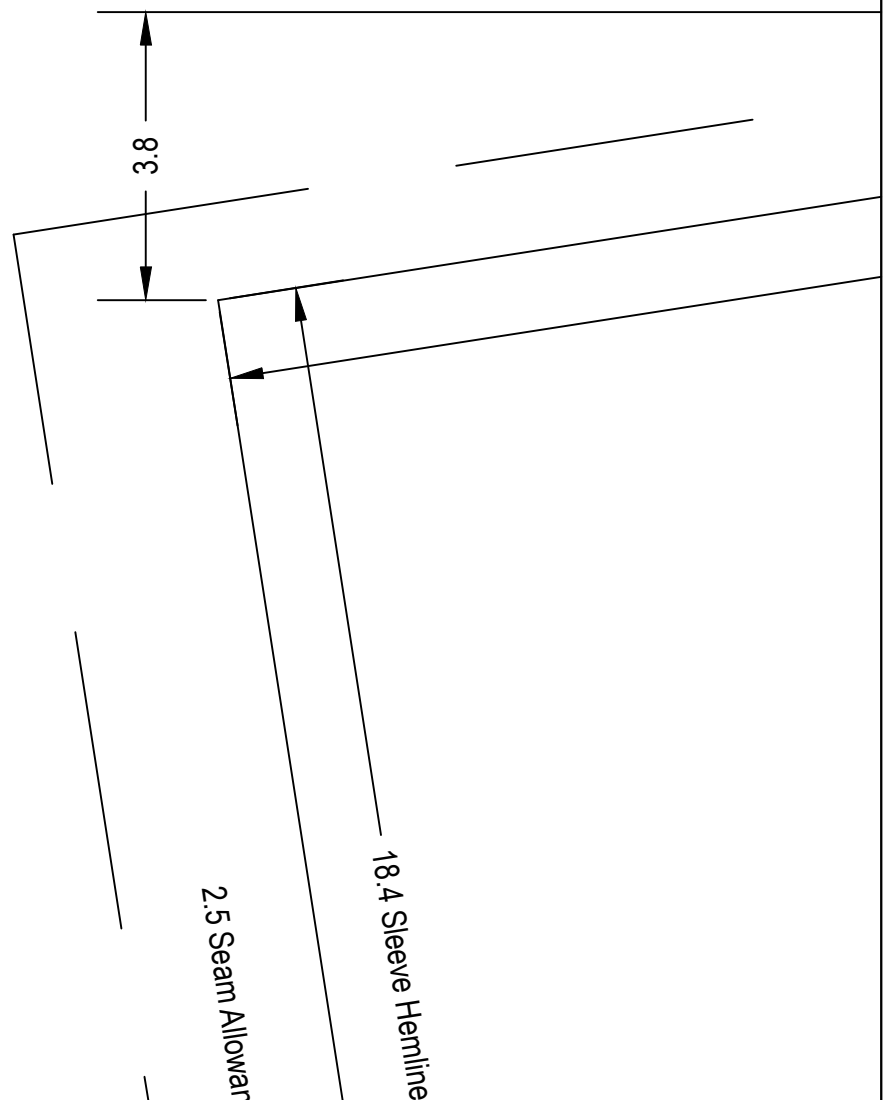

2B

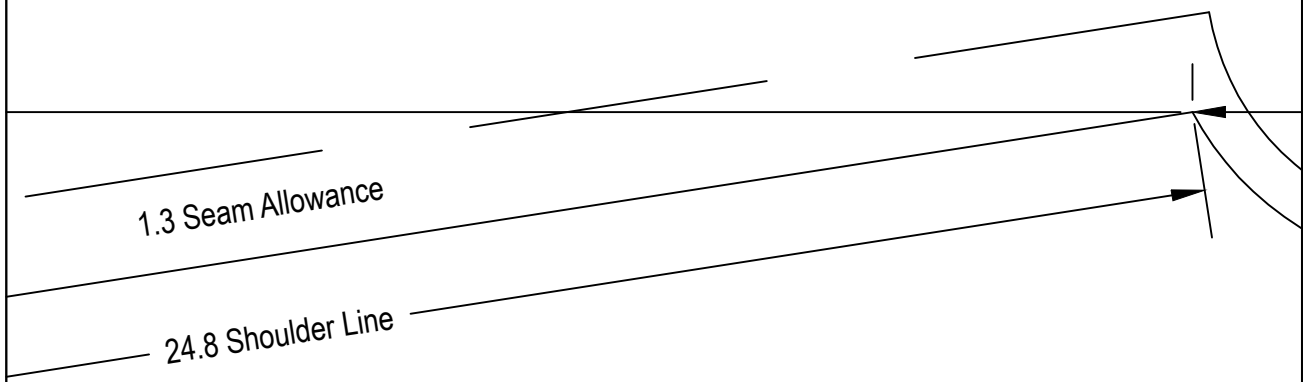

2C

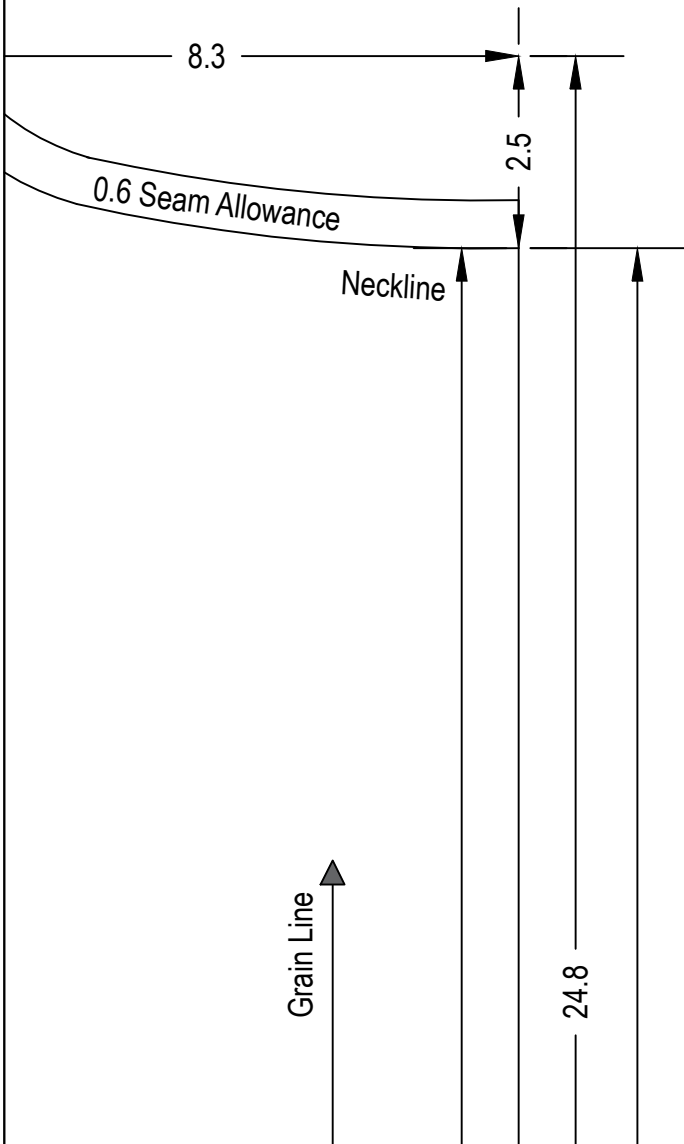

2D

ce

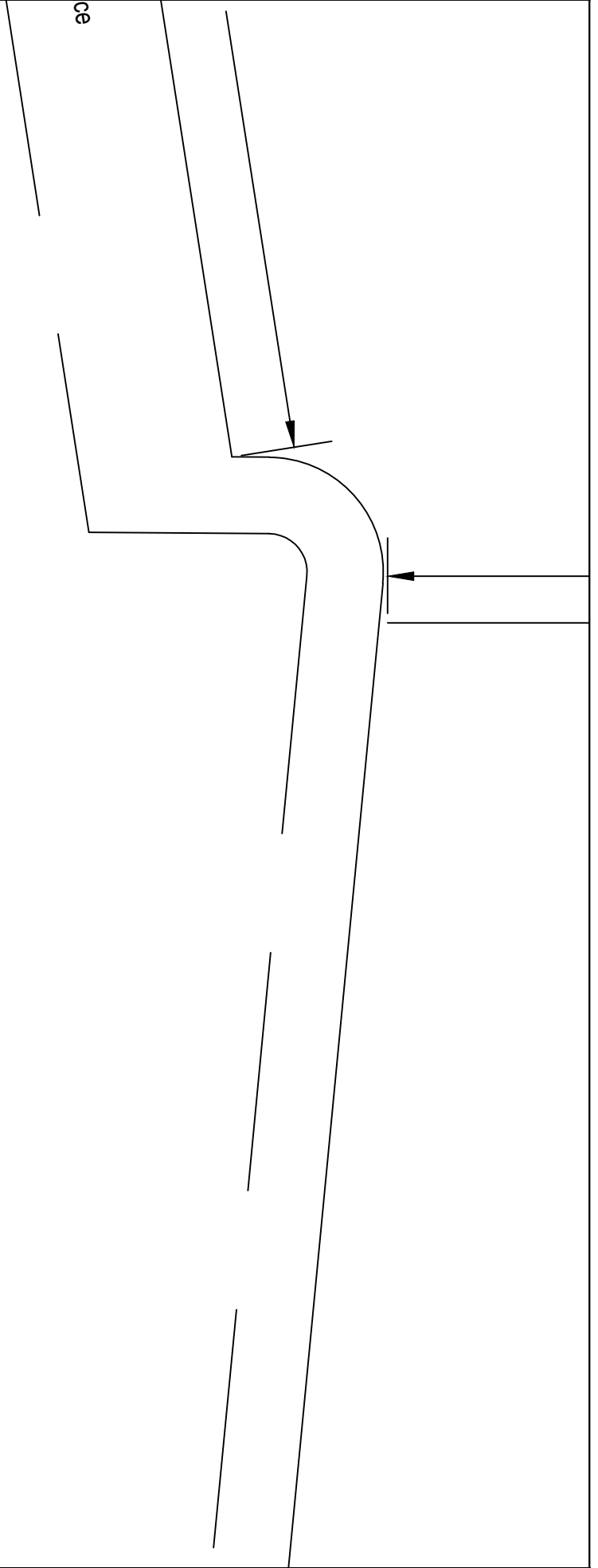

2E

27.3 Across Chest

2F

ON FOLD

22.2 Center Back

Chest Level



2G

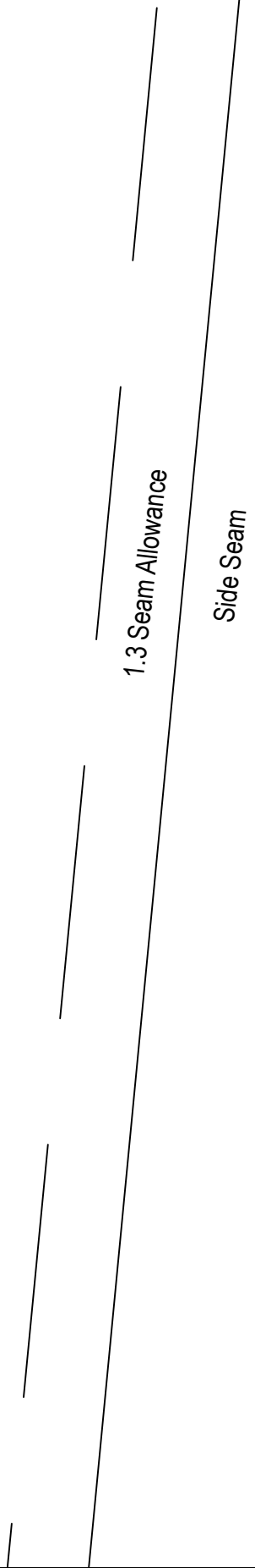

2H



21

— 51.4 —

— 76. —

2J

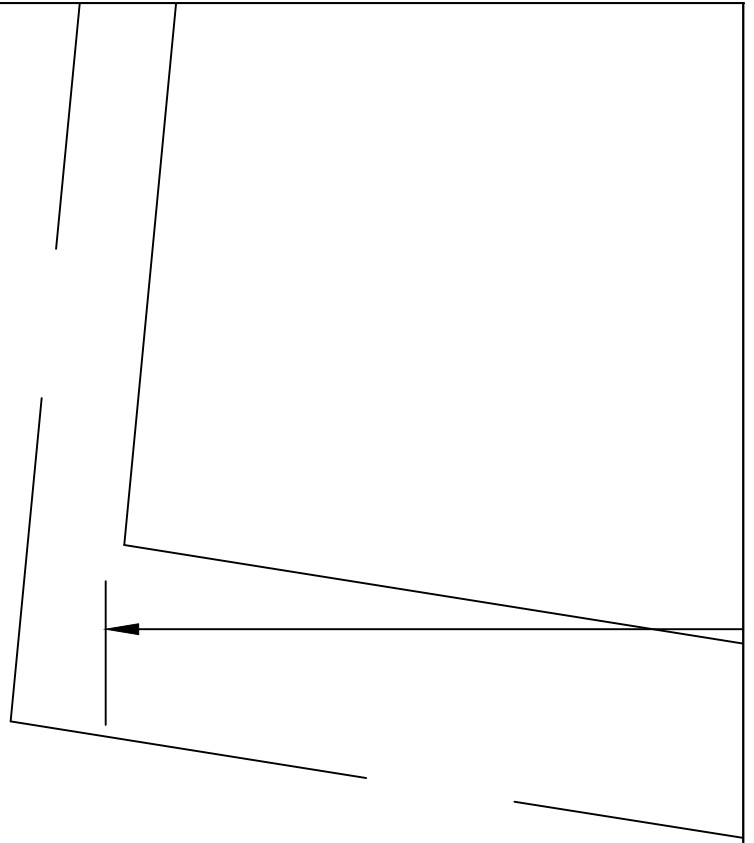

2K

32.4

1.3 Seam Allowance

2L

Hemline

